

Searches for Supersymmetry

Cristóvão B. da Cruz e Silva



LABORATÓRIO DE INSTRUMENTAÇÃO
E FÍSICA EXPERIMENTAL DE PARTÍCULAS



Outline

- Overview of last lecture
- Simplified Susy Models
- Search for supersymmetric top quarks decaying via the 4-body mode
- Other searches

Supersymmetry

- Compared to the SM, Supersymmetry introduces a new symmetry between fermions and bosons
- The new symmetry implies the existence of new particles
 - New particles cancel, by construction, quadratically divergent terms to the one loop corrections to the Higgs mass squared → Elegant solution to the Hierarchy Problem
 - Lightest supersymmetric particle can be a good dark matter candidate
- Supersymmetry must be a broken symmetry or the supersymmetric particles would have same mass as SM particles and would already be discovered
- Introduce minimal, but complete, set of terms to the Lagrangian to construct the MSSM
 - 124 free parameters

Supersymmetry Particle Spectra

- The parameters of the model are chosen, then the supersymmetric particle masses can be computed and the spectra is drawn →
- It is possible that not all particles are within reach of an experiment: LHC → $\sqrt{s} = 14$ TeV
 - From an experimental point of view, we only care about the particles we can reach
 - If working on an analysis searching for the selectron, assume the selectron is in reach and its decay chain products as well
- Vast parameter phase space of MSSM is challenging → use simplified models for setting limits

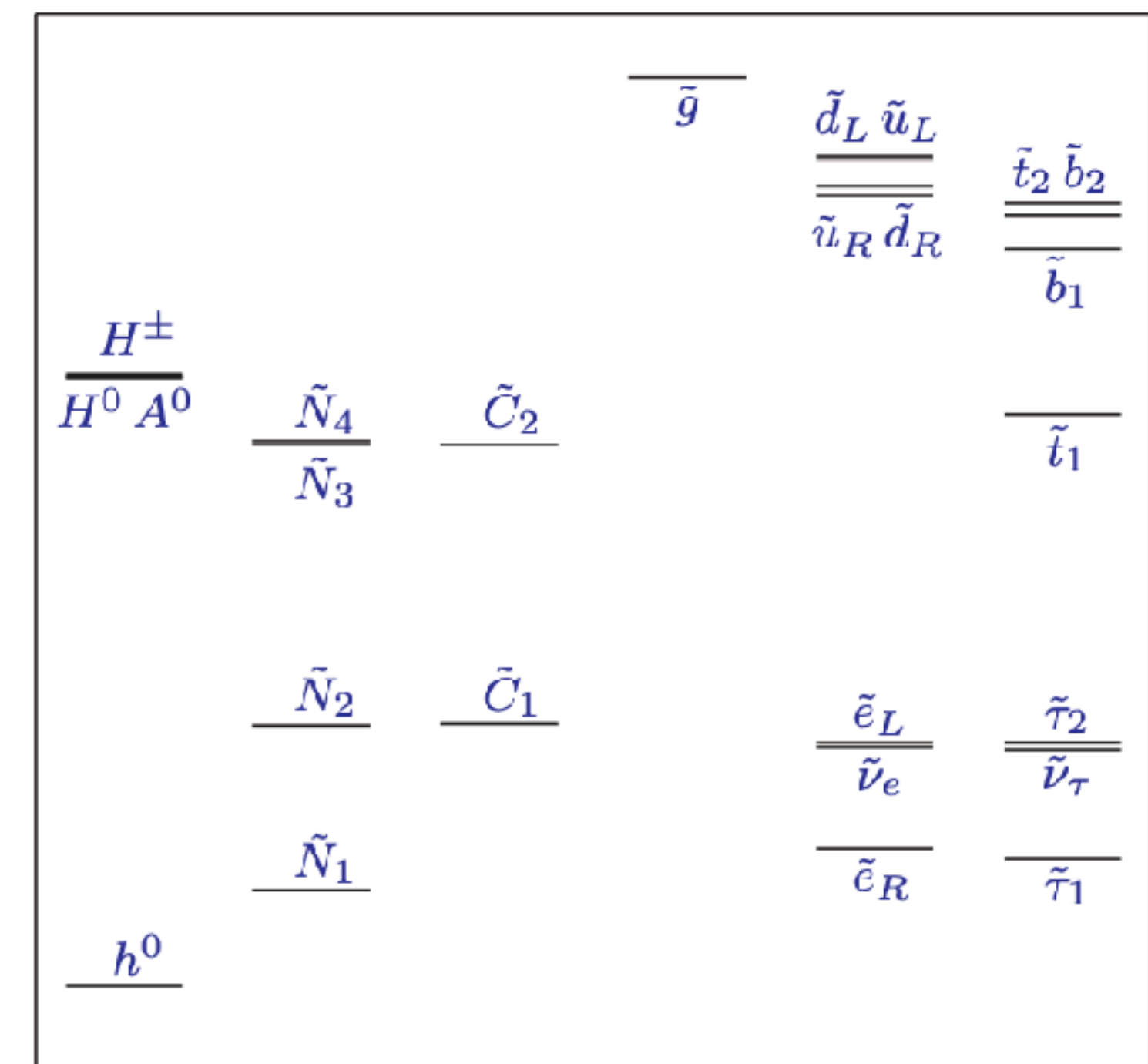

Taken from "Supersymmetry Primer"

Simplified SuSy Models

- Phenomenological MSSM:
 - MSSM with some assumptions:
 - R-parity is conserved \rightarrow LSP is stable
 - No new CP violation term beyond the SM CKM matrix
 - No flavour changing neutral currents at tree level
 - For the first and second generation, the left and right handed sparticles are degenerate and tri-linear couplings are negligible
 - pMSSM has 19 additional parameters compared to the SM
- Effective Field Theory and Simplified Model Spectra: *Not SuSy Specific*
 - Take SM Lagrangian and expand it with minimal terms to only introduce particles of interest
 - Minimum amount of parameters for a specific scenario
 - May not correctly account for interference and loop effects
 - Care must be taken when interpreting results \rightarrow Limits are typically set on $\sigma \times \text{BR}$
- With simplified models, it is easier to produce MC signal samples scanning the parameter space (i.e. one sample for each desired point in the parameter phase space)

Supersymmetric Top Quark

- We are interested in models that provide a Dark Matter candidate so the lightest supersymmetric particle (LSP) must be neutral
- Search for stop is an interesting avenue because the high top mass leads to a potentially large splitting between the mass of the two stop particles \rightarrow lightest stop could be the lightest squark
- Focus on the situation where stop is next-to-lightest supersymmetric particle (NLSP) and neutralino is the LSP

- Stop decays to a top and a neutralino (R-parity conservation and baryon number conservation)

$$\tilde{t}_1 \rightarrow \tilde{\chi}_1^0 + t$$

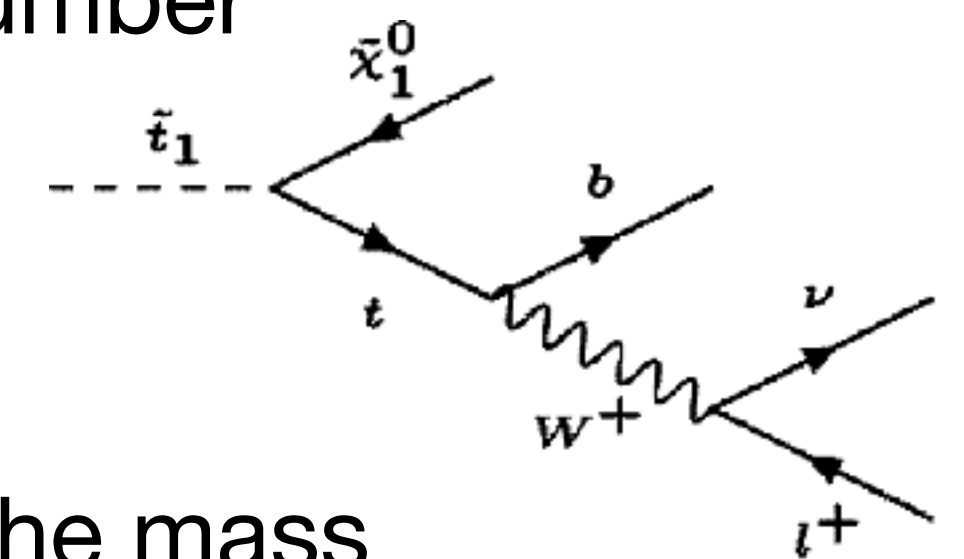
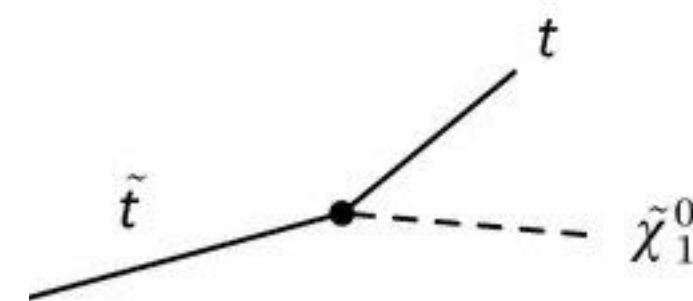

- Cosmological data seems to favour stops in a compressed region, i.e. where the mass difference between the lightest stop and the LSP is small. These models are compatible with the relic density of dark matter

<https://arxiv.org/abs/hep-ph/9911496>

<https://arxiv.org/abs/hep-ph/0403224>

Compressed Stop Scenario

- If mass difference is smaller than the top quark mass, the decay of the stop to a top and a neutralino is not kinematically allowed

$$\Delta m \equiv m(\tilde{t}_1) - m(\tilde{\chi}_1^0) \leq m(t) \approx 170 \text{ GeV}$$

- The decay is only allowed if the top quark is a “virtual particle” and immediately decays to a W boson and a lighter quark (normally b quark) → Stop must undergo a “3-body” decay:

$$\tilde{t}_1 \rightarrow \tilde{\chi}_1^0 + b + W^\pm$$

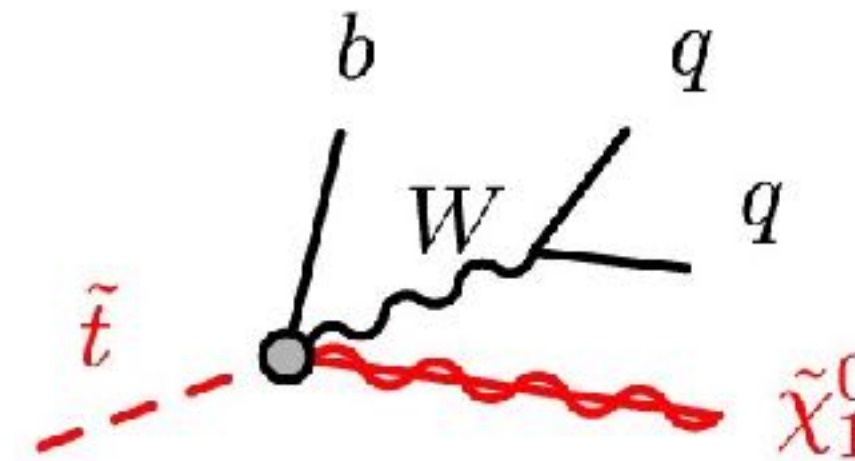

- If mass difference is smaller than the W boson mass, the 3-body decay is also not kinematically allowed

$$\Delta m \equiv m(\tilde{t}_1) - m(\tilde{\chi}_1^0) \leq m(W) \approx 80 \text{ GeV}$$

- Both the top quark and W boson decay products are virtual and immediately decay → Stop must undergo a “4-body” decay:

$$\begin{aligned} \tilde{t}_1 &\rightarrow \tilde{\chi}_1^0 + b + l^\pm + \nu_l \\ \tilde{t}_1 &\rightarrow \tilde{\chi}_1^0 + b + q + q \end{aligned}$$

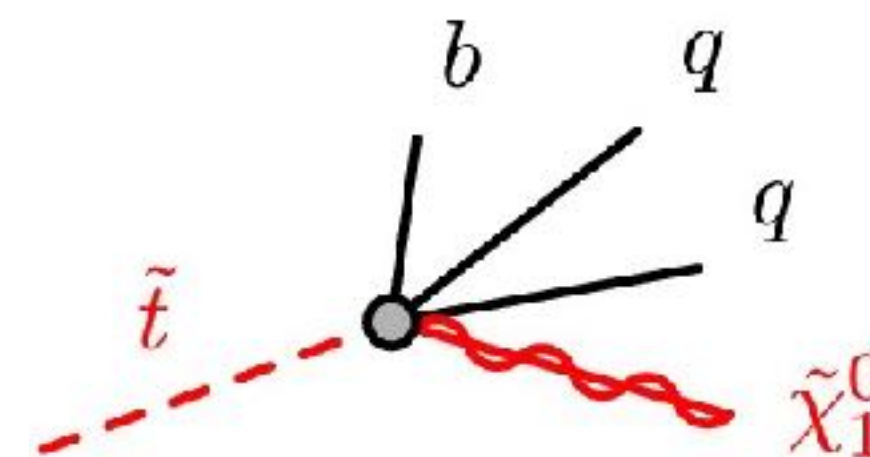

Phase Space of Stop as NLSP

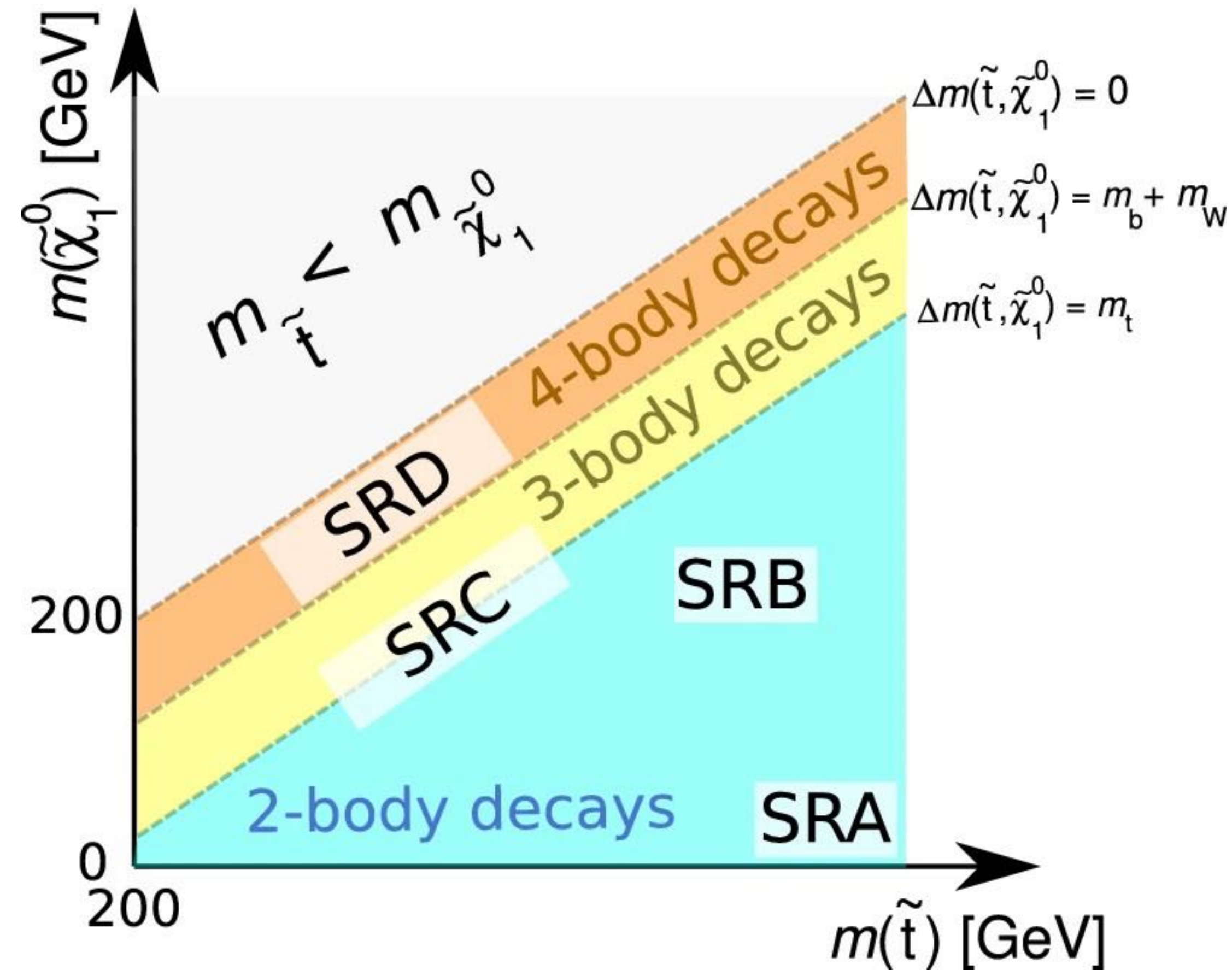

Taken from: [Eur. Phys. J. C 80 \(2020\) 737](#)

Search for 4-body Stop Decay @CMS

- If one stop decays to a lepton and the other to hadrons:
- Experimental Signature:
 - 1 lepton
 - MET
 - 4 jets, 2 of which are b-jets
- Choose semi-leptonic channel because few processes producing leptons at LHC \rightarrow less background at the cost of lower cross section

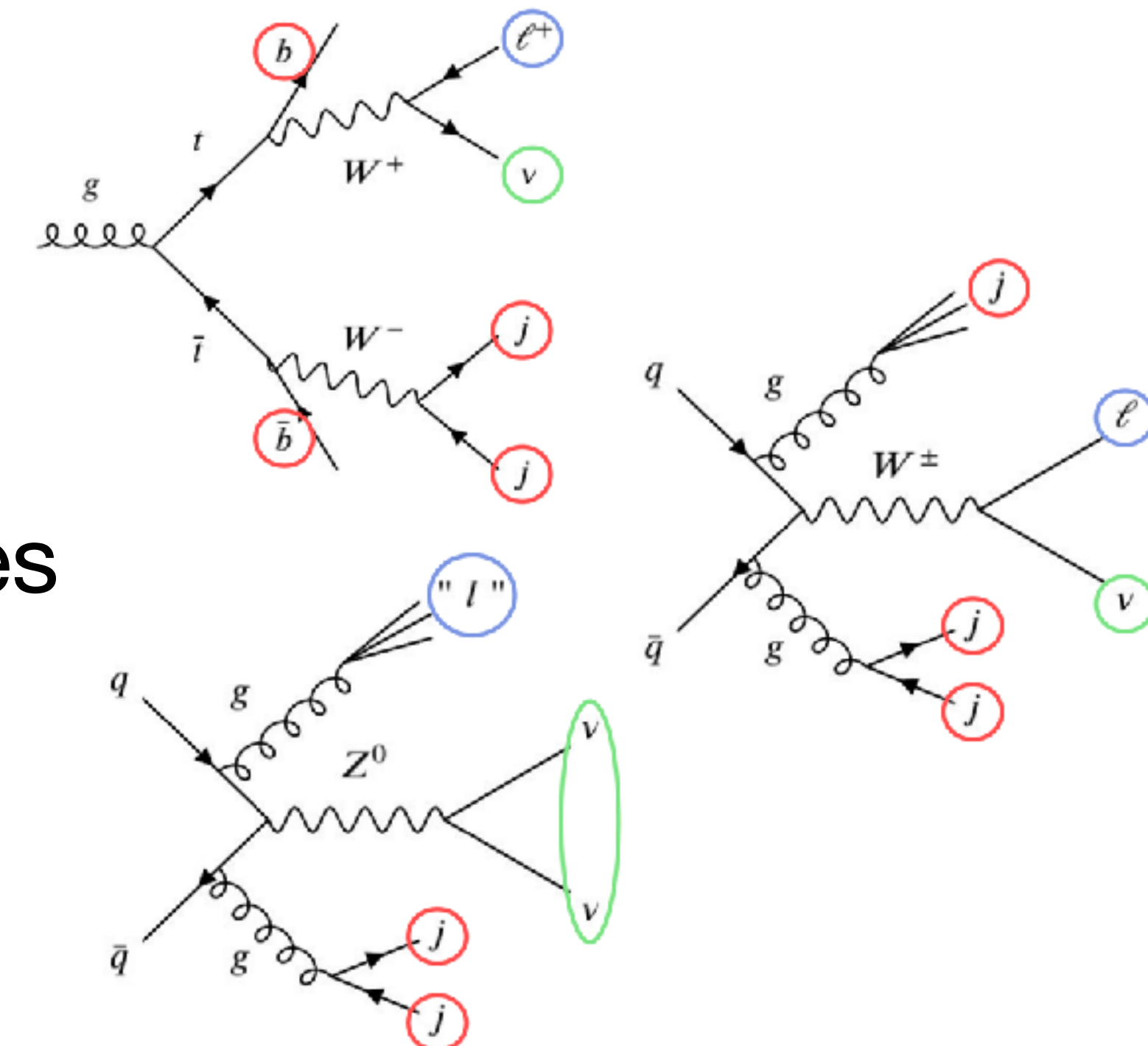
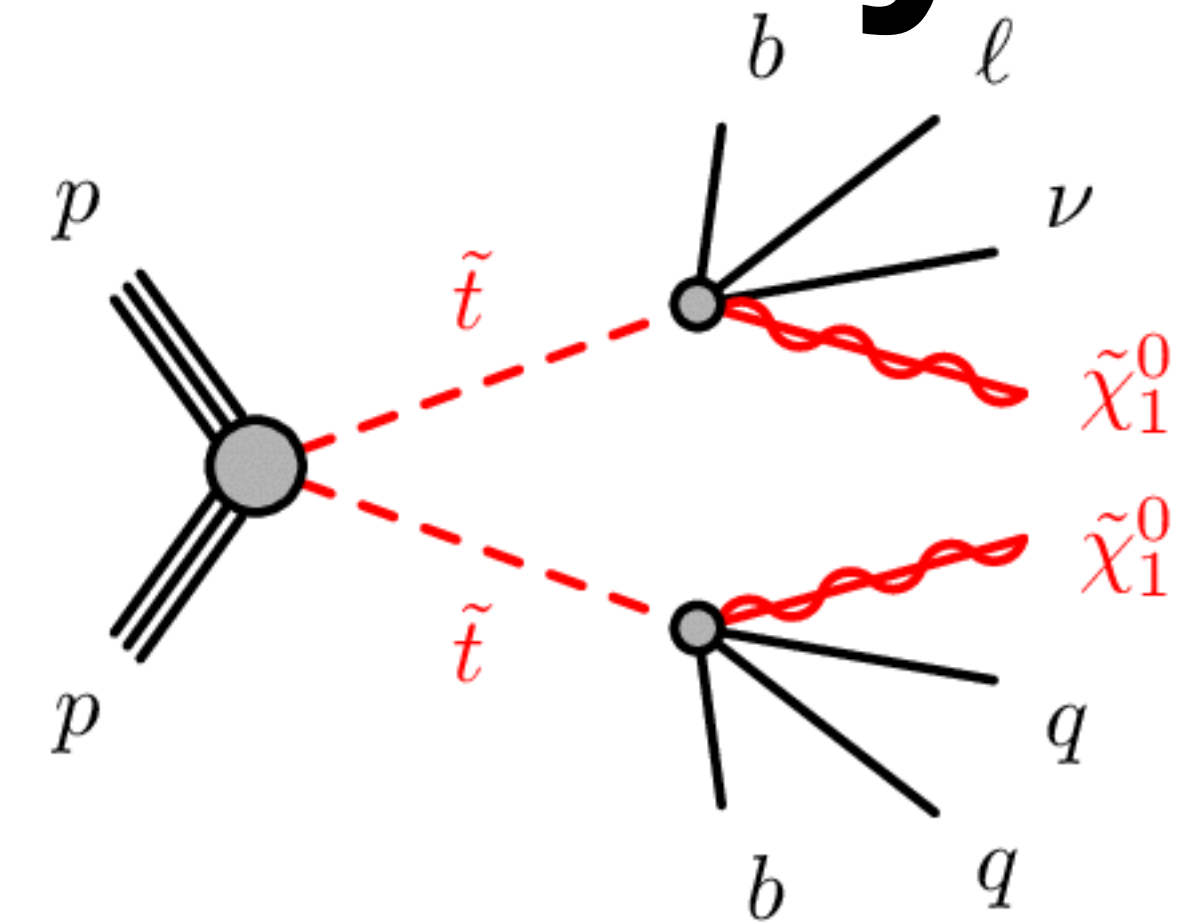

Initial State Radiation Jet

- Initial State Radiation (ISR) Jet balanced against the stop pair \rightarrow boosts the stop pair
- Ultimately boosts decay products, particularly neutralinos \rightarrow Increased MET
- Increased MET has better reconstruction

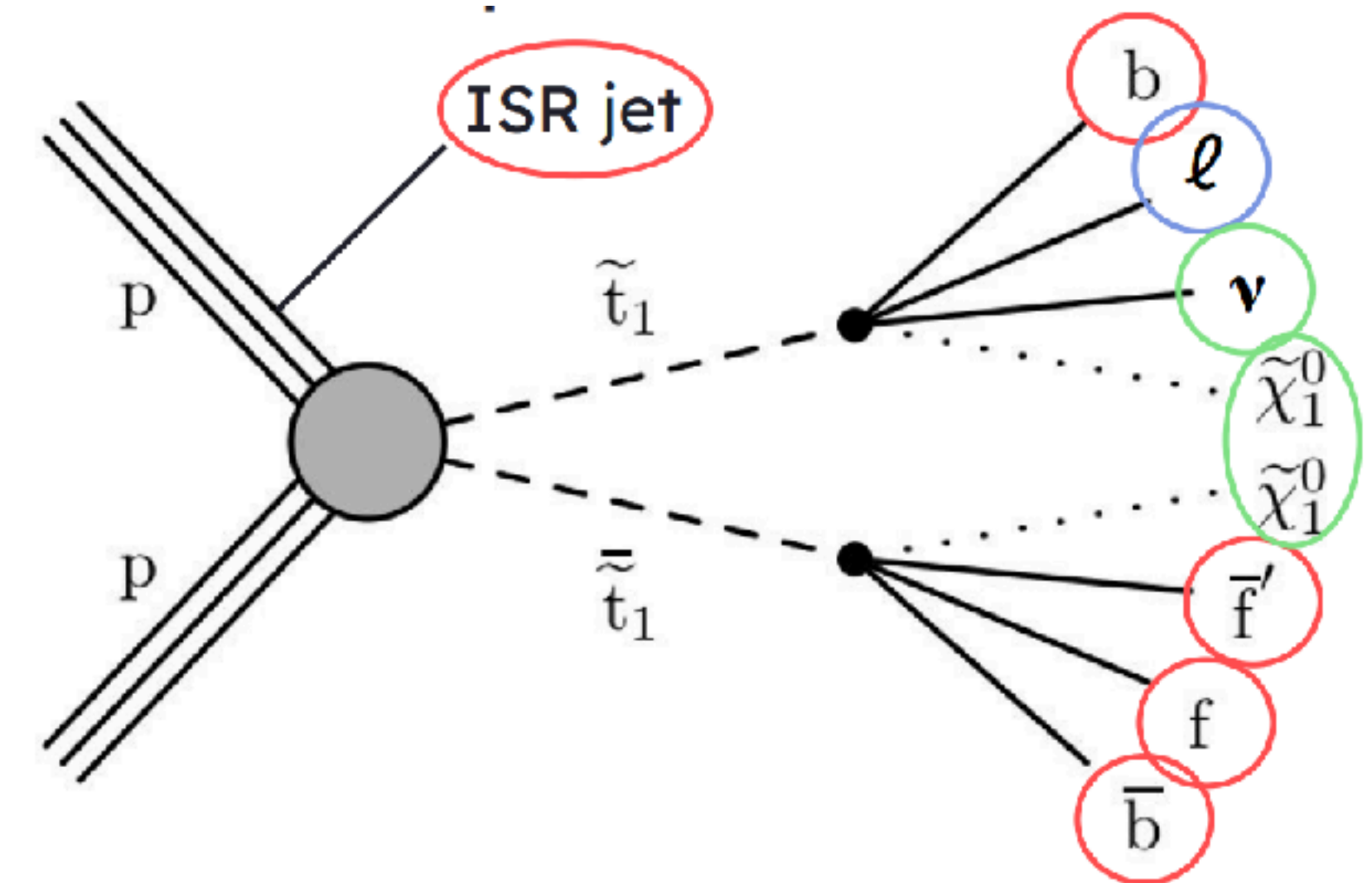

Stop 4-body Preselection

2017 Data/MC

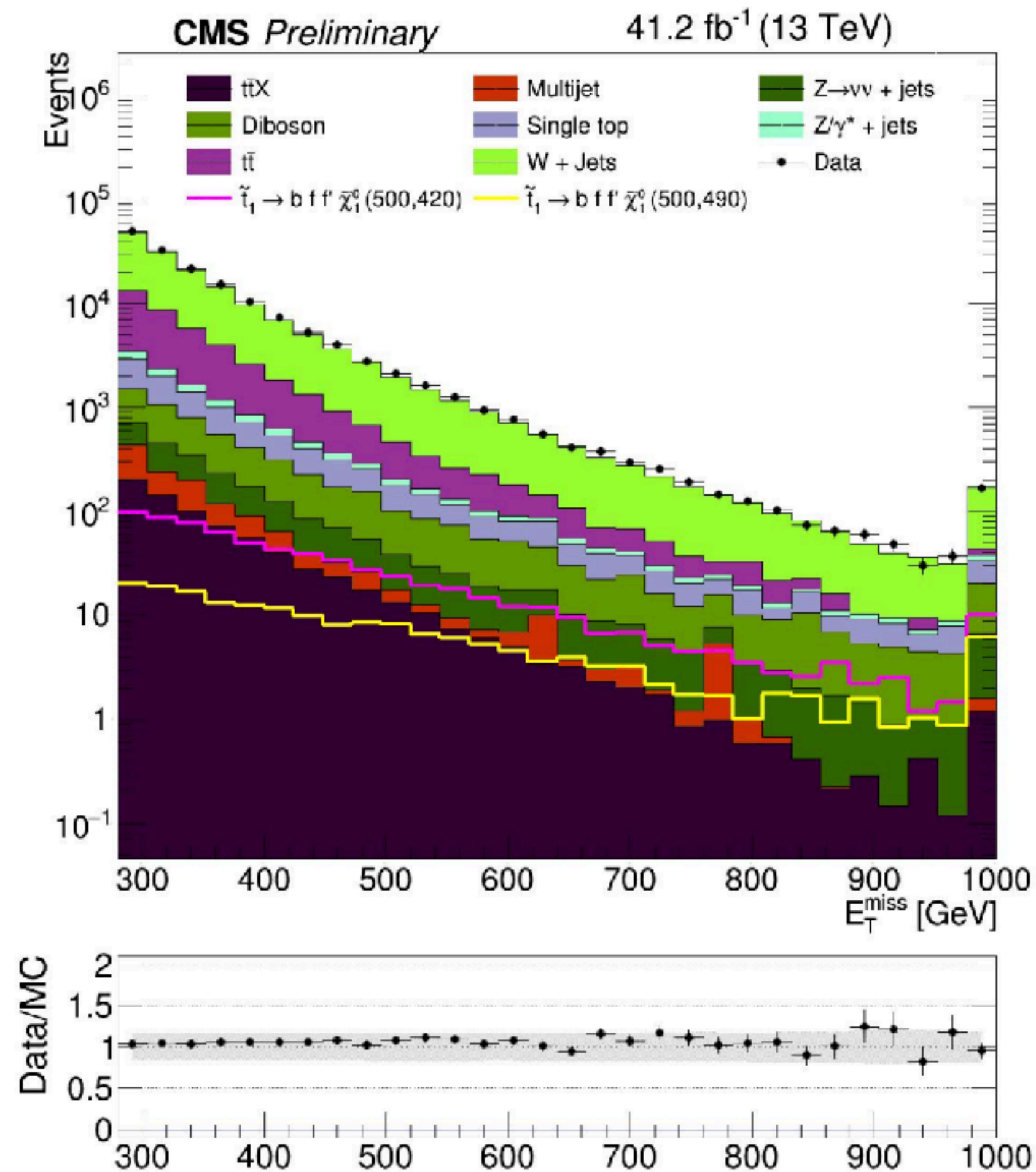

- Require exactly 1 lepton \rightarrow reduce multilepton $t\bar{t}b\bar{a}$ background
- $HT > 200 \text{ GeV}$ \rightarrow reduce W+Jets background
- $p_T(\text{Jet}_1) > 110 \text{ GeV}$ \rightarrow preferentially select events which boost against an ISR jet
- $\Delta\phi(\text{Jet}_1, \text{Jet}_2) < 2.5$ if $p_T(\text{Jet}_2) > 60 \text{ GeV}$ \rightarrow reduce multijet background
- $\text{MET} > 280 \text{ GeV}$ \rightarrow Since Neutralinos should not be detected

Where is b-jet requirement?

Stop 4-body Kinematics

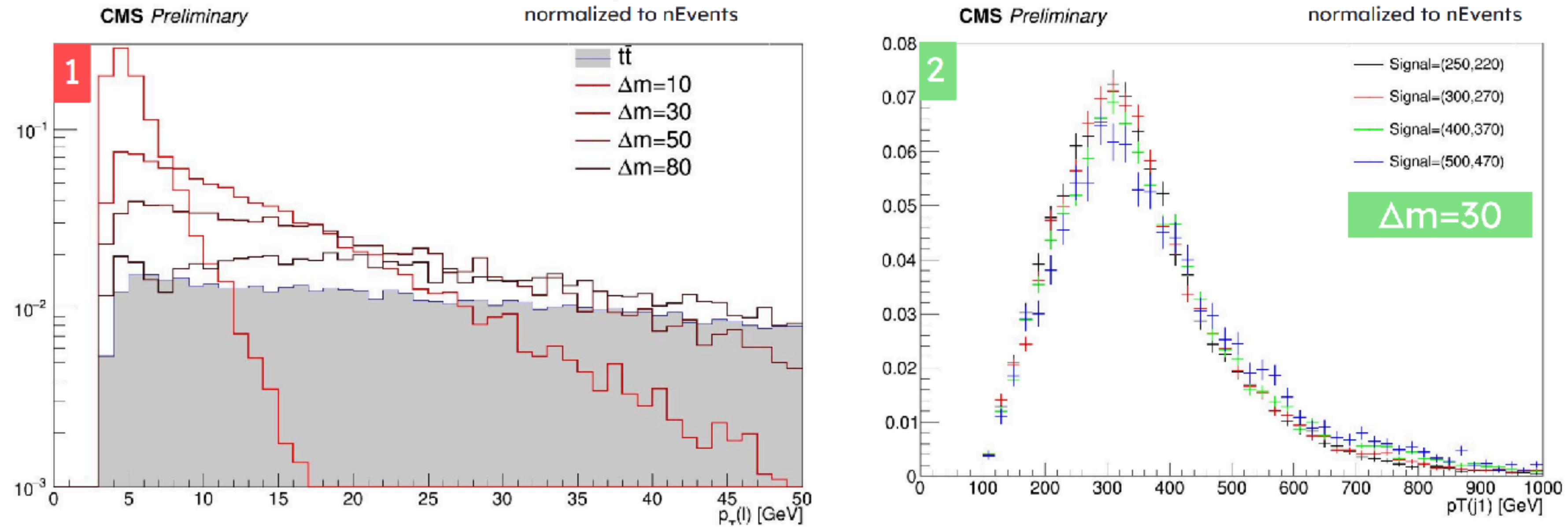

- Signal points with **different Δm** have different kinematic distributions
- Signal points with the **same Δm** have similar kinematic distributions

Exploit this to reduce the parameter space and aggregate the signal samples into Δm bins,
then train one MVA for each bin

b-Jet variables fed to the MVA

Stop 4-body Final Selection

- The final selection is defined as a cut on the MVA (in this case a BDT) output
 - i.e. one selection for each Δm (for each year)
- Cut value is defined through minimization of the expected upper limit on the σ
- Main backgrounds are estimated through DD methods, to not depend on MC in extreme corners of the phase space where MC statistics may not be sufficient or modelling may have limitations

Stop 4-body Final Selection

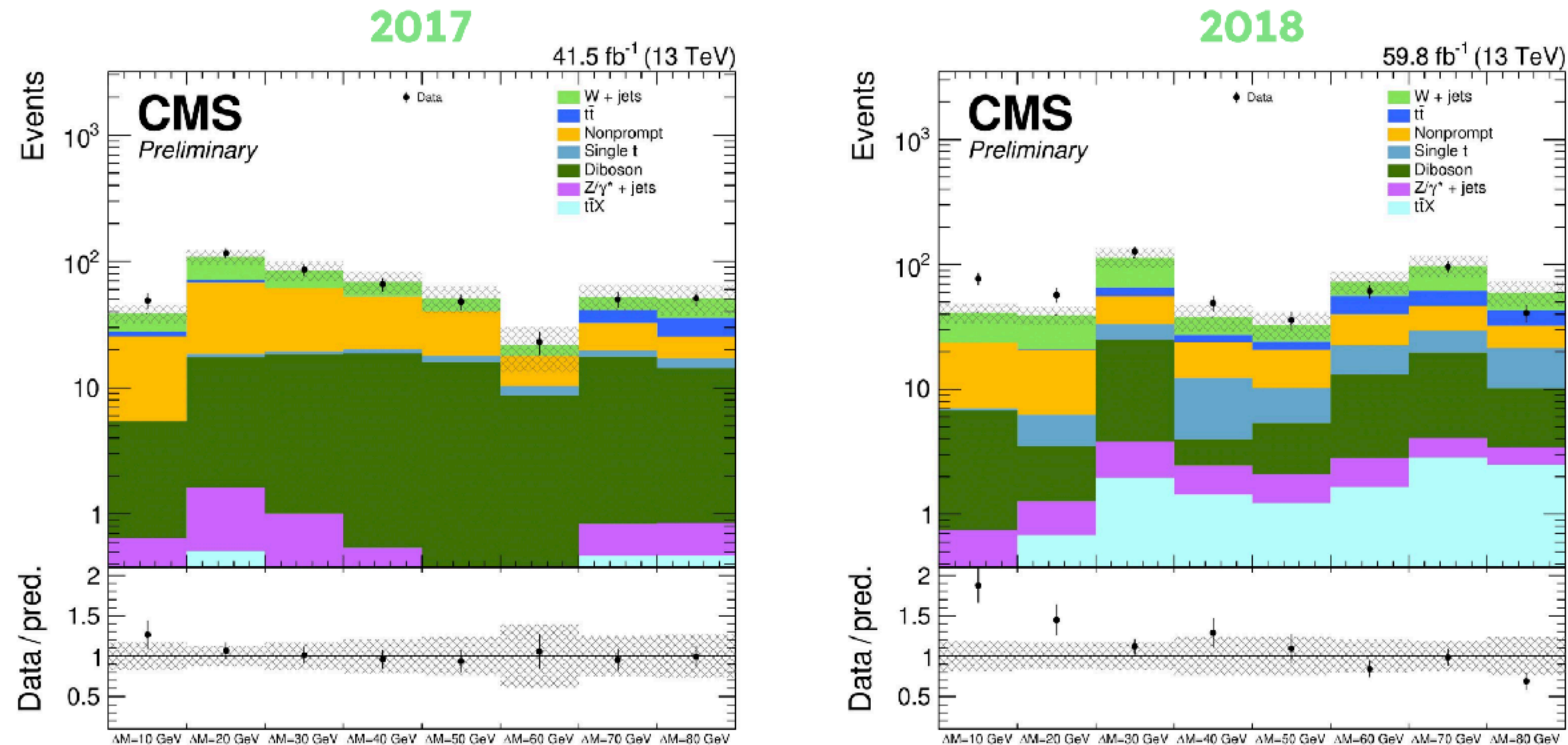

nb: Even though all selections are shown in a single plot, the selections are not mutually exclusive so a single event may end up in multiple “bins”. In other words, do not treat all bins together as a single signal region, each Δm must be treated on its own

Stop 4-body Final Result

- The yields across the 3 years of Run II (2016, 2017 and 2018) are interpreted together and a limit on the σ is set (or $\sigma \times \text{BR}$ for models where there are competing stop decay channels)

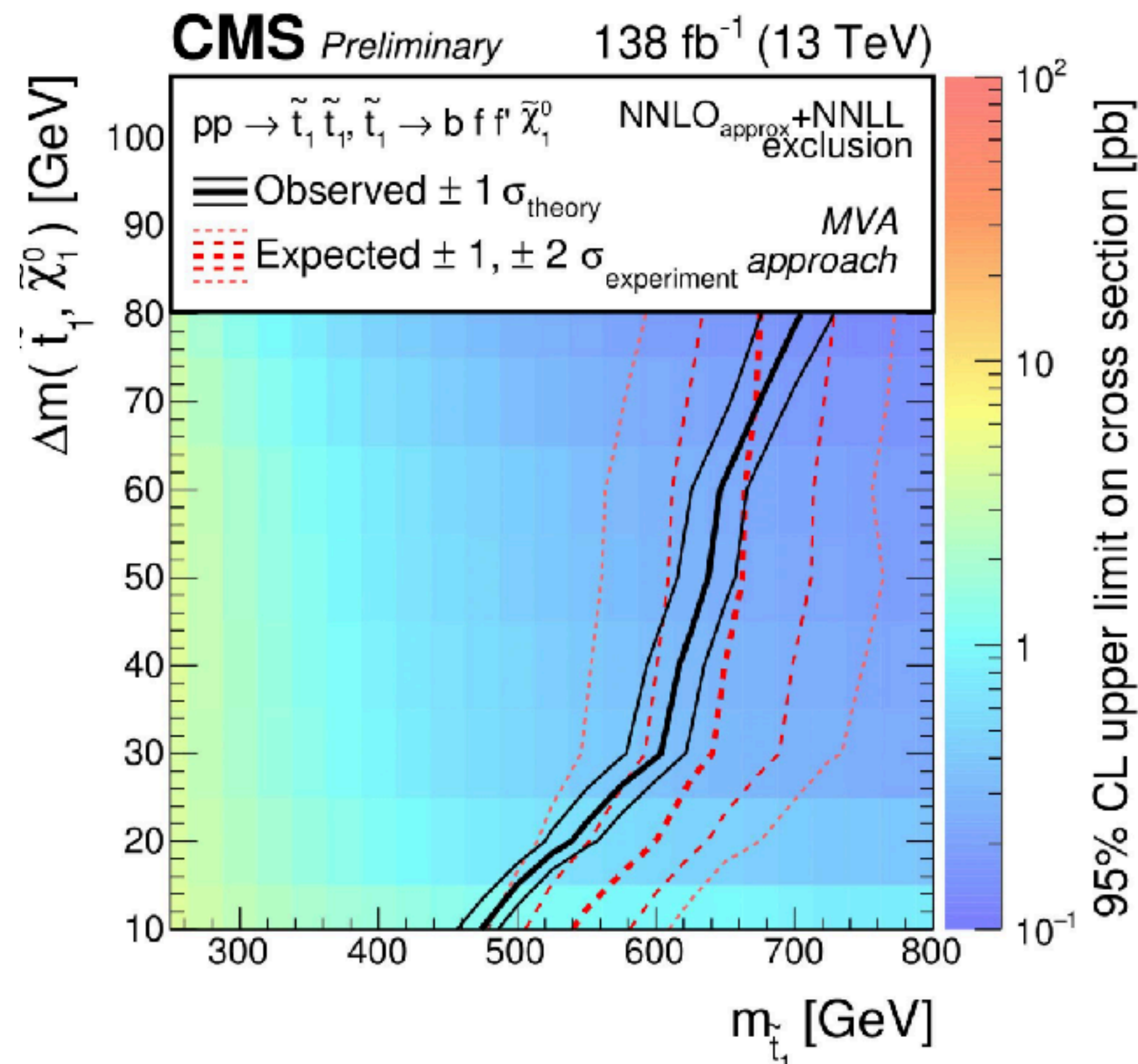

- Excluded top squark masses up to:
 - 480 GeV at $\Delta m = 10$ GeV
 - 700 GeV at $\Delta m = 80$ GeV
- Disagreement at $\Delta m = 10$ GeV (local significance of 2.5σ) was scrutinized and no issues found, Run III data will tell whether statistical fluctuation or something interesting...

Result on Stop 4-body

@Atlas

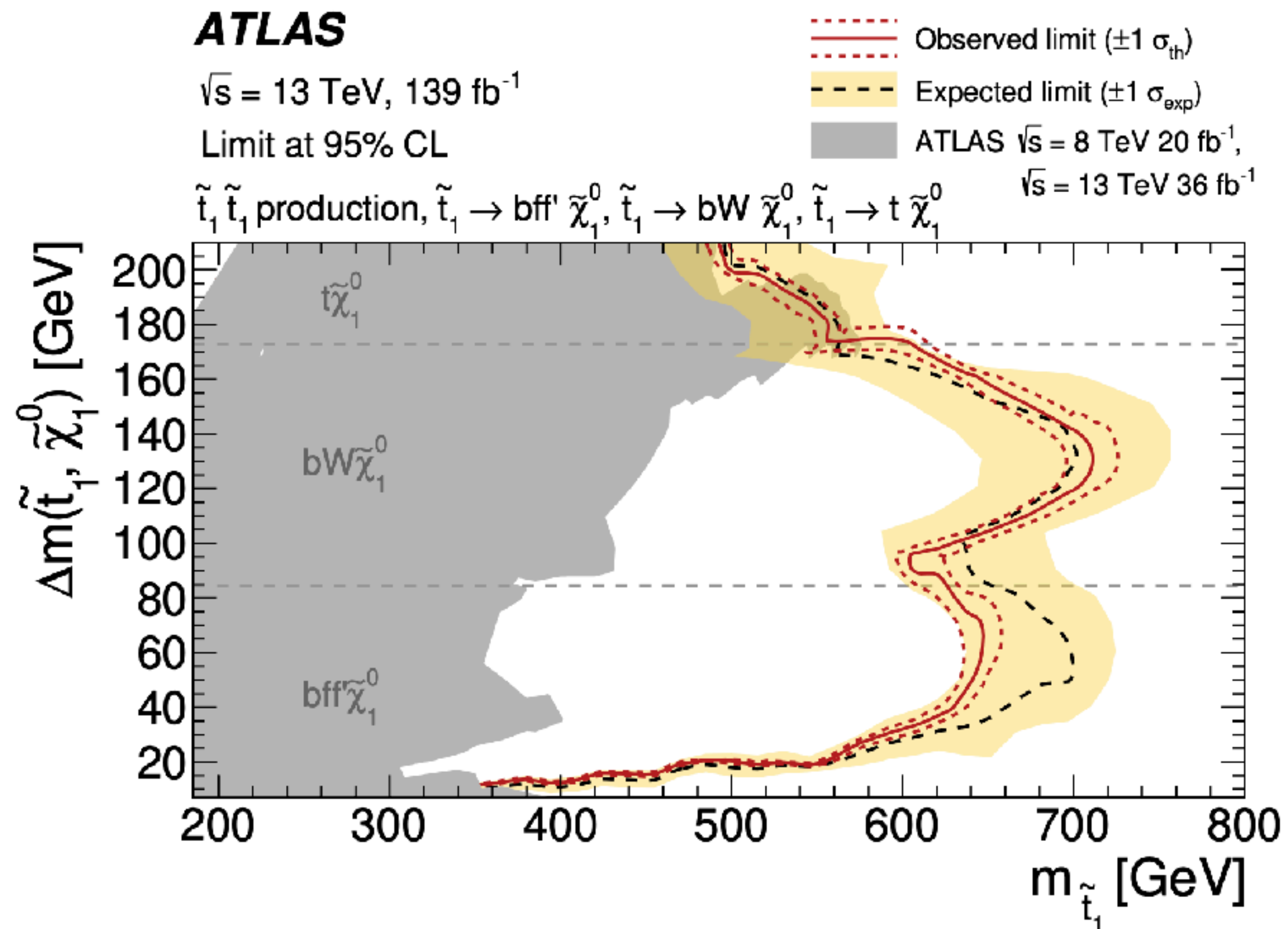

- Same process*, different analysis approach
- Traditional Cut&Count/Shape-Fit instead of ML
 - Several signal regions, with different selections, each for a non-overlapping range of Δm
- Both approaches have a similar performance
- Only at very low Δm does the ML approach exhibit significantly higher sensitivity

Fully Hadronic Compressed Stop Decay

- Covers the search for several scenarios, all with fully hadronic final states, such as:

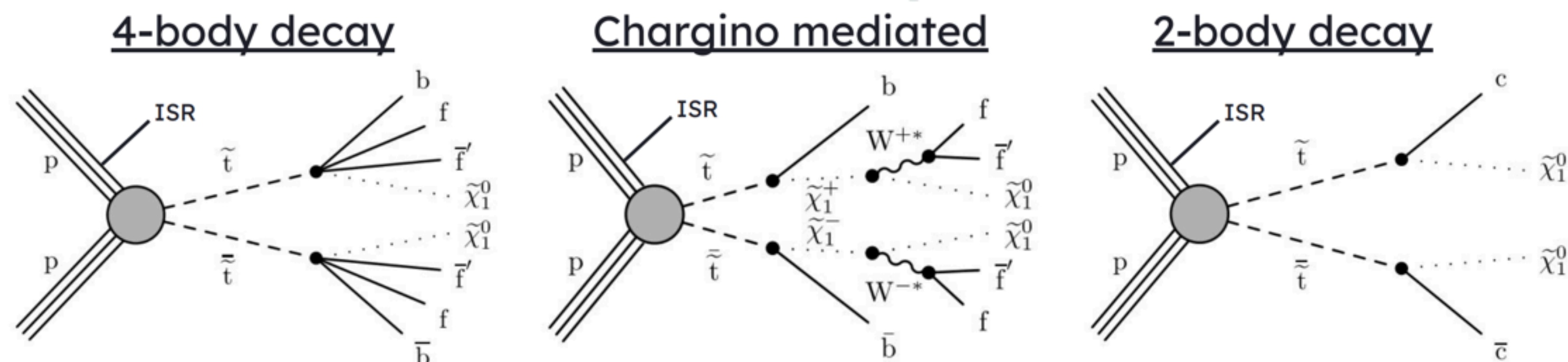

- Uses a cut&count analysis approach

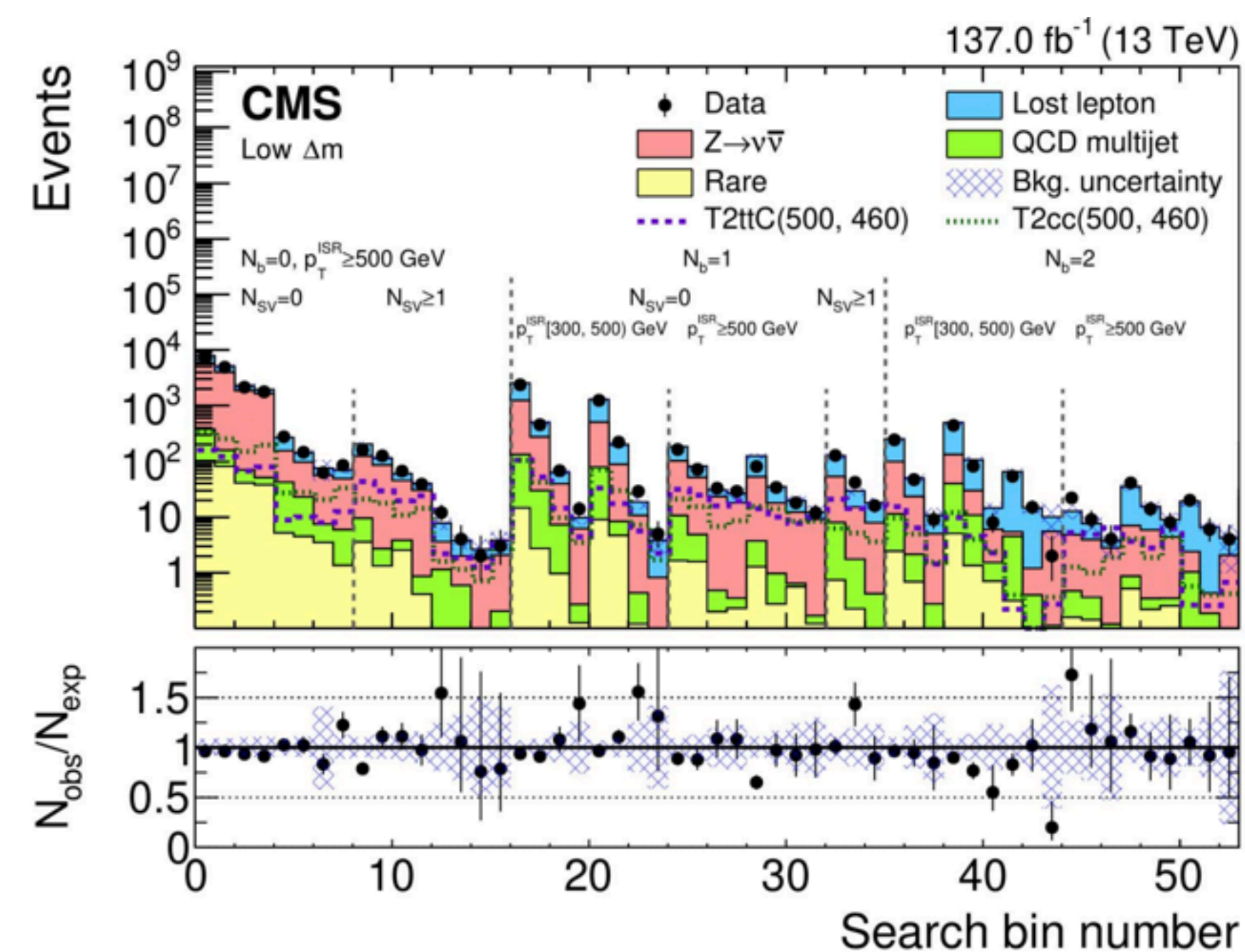
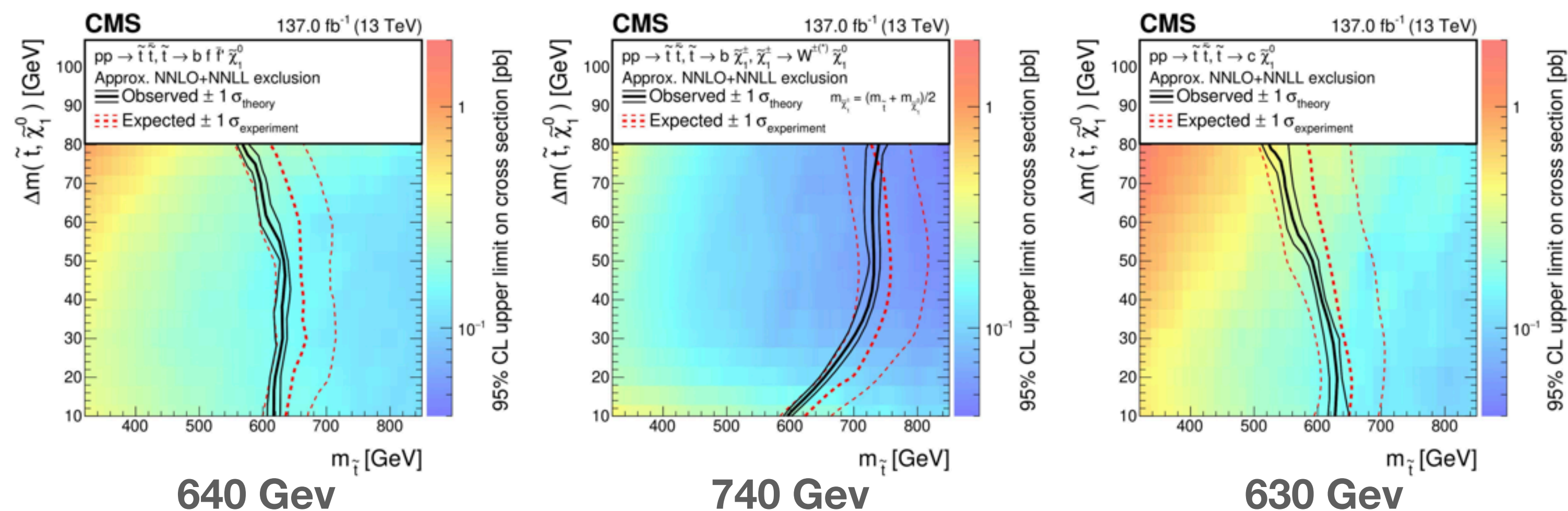

Two Lepton Stop Decay

- Covers the search for several scenarios, all with two leptons in the final state, such as:

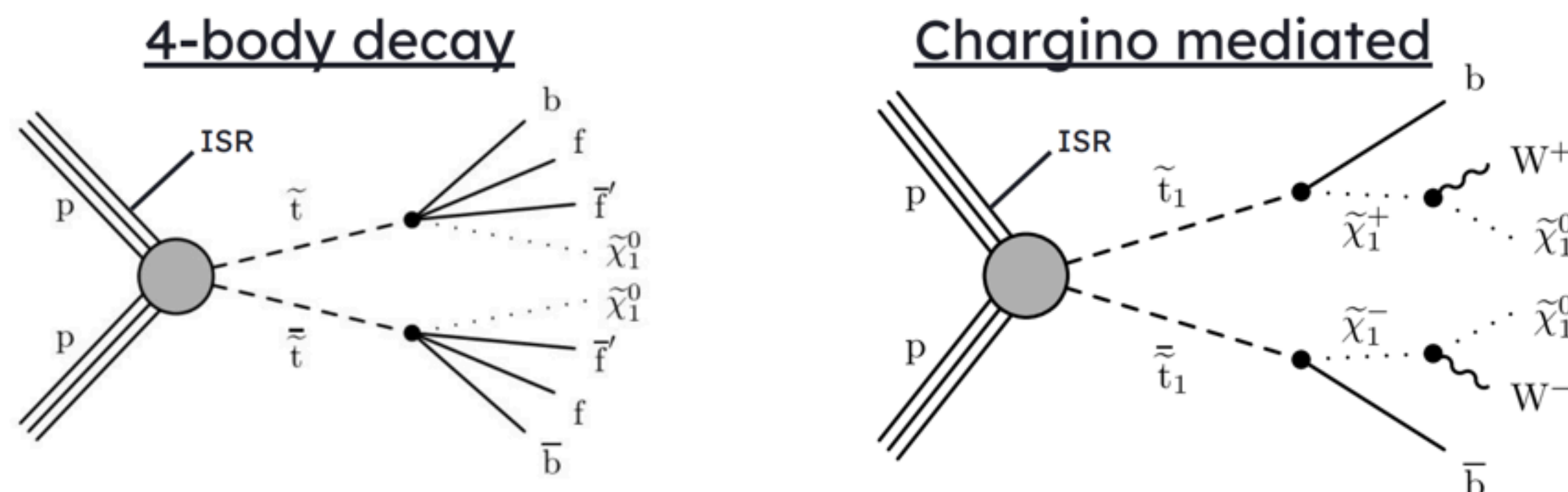

- Uses a cut&count analysis approach

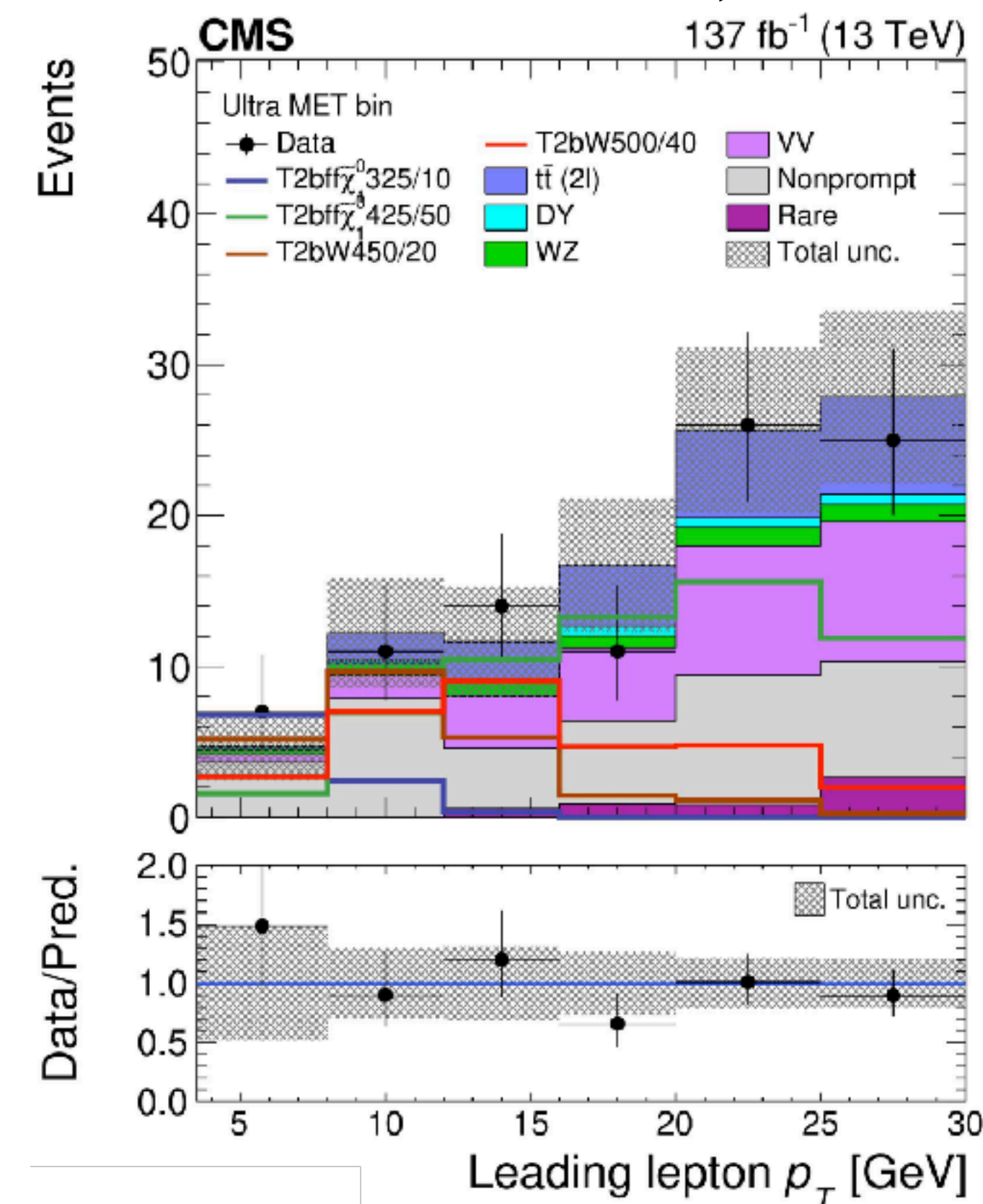
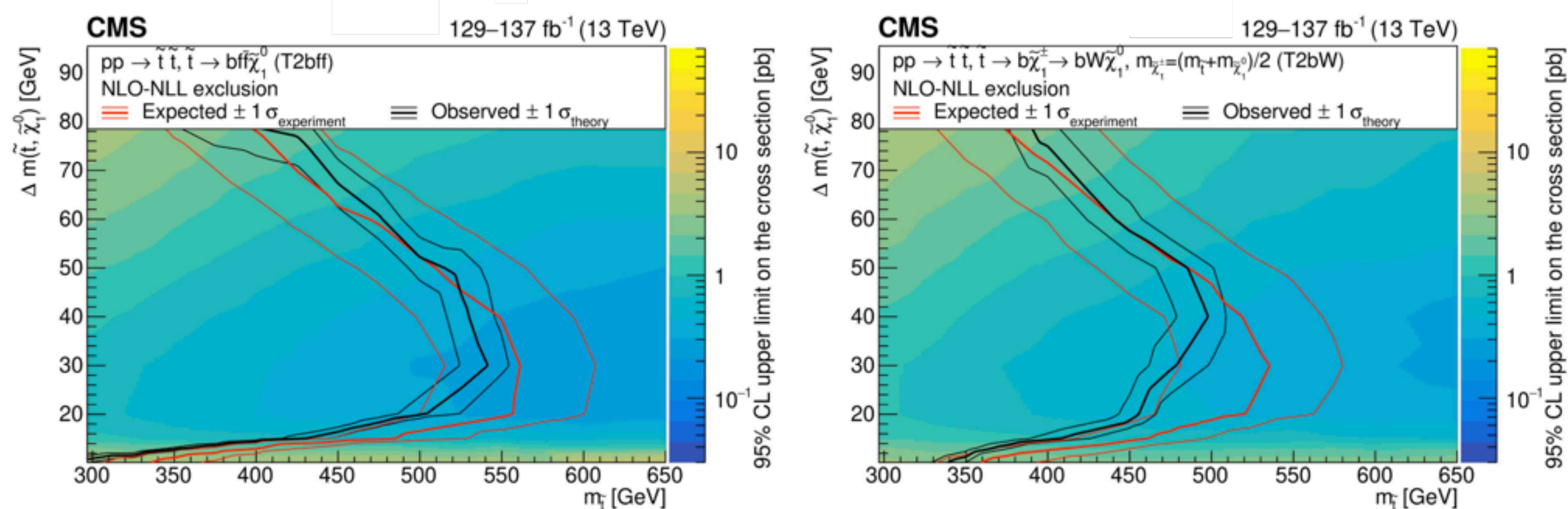

Selection not optimized for the varying Δm

Supersymmetric Tau Searches

- Similar to the stop, the stau has the largest splitting of the lepton superpartners \rightarrow stau is often the lightest supersymmetric lepton
- Does not depend on QCD, so limits set on stau impose limits on MSSM independent of colour sector
- Light stau with low Δm also compatible with cosmology results and relic dark matter density [hep-ph/9905481](https://arxiv.org/abs/hep-ph/9905481)
[JHEP08\(2011\)151](https://arxiv.org/abs/hep-ph/9905481)
- So search for events where stau is the NLSP

Direct Stau Pair Decaying to Hadrons

- Hadronic Decay considered due to the higher branching ratio (semi-leptonic/leptonic decay are “cleaner” but low branching ratio → even more challenging)

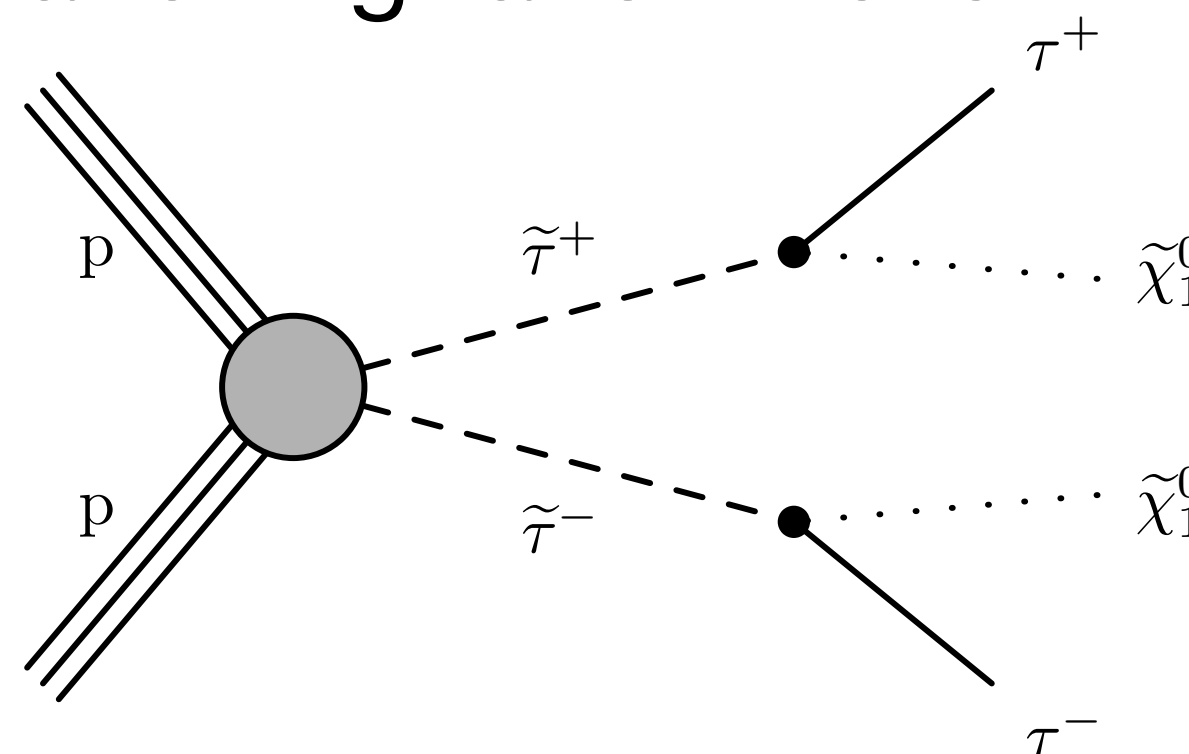

- Results depend on stau helicity
- Challenging low cross section →
- Use embedding technique to estimate τ backgrounds from SM

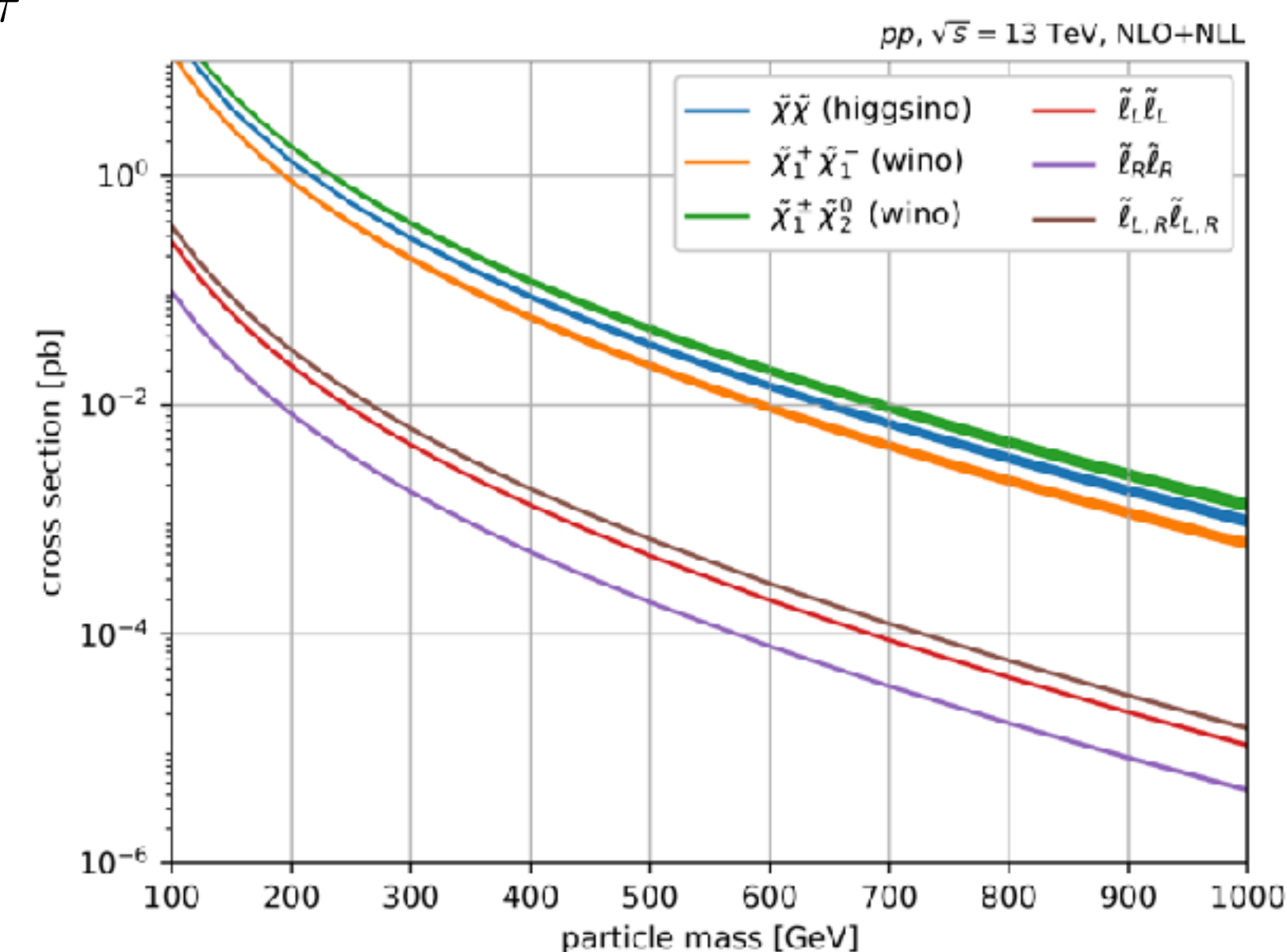

Direct Stau Pair Decaying to Hadrons

- Cut&Count approach:
- For an LSP of 1 GeV:
 - Mass degenerate: stau masses 90 – 400 GeV excluded.
 - Left-handed: stau masses 115 – 340 GeV excluded.
 - Right-handed: stau masses 140 – 240 GeV excluded.

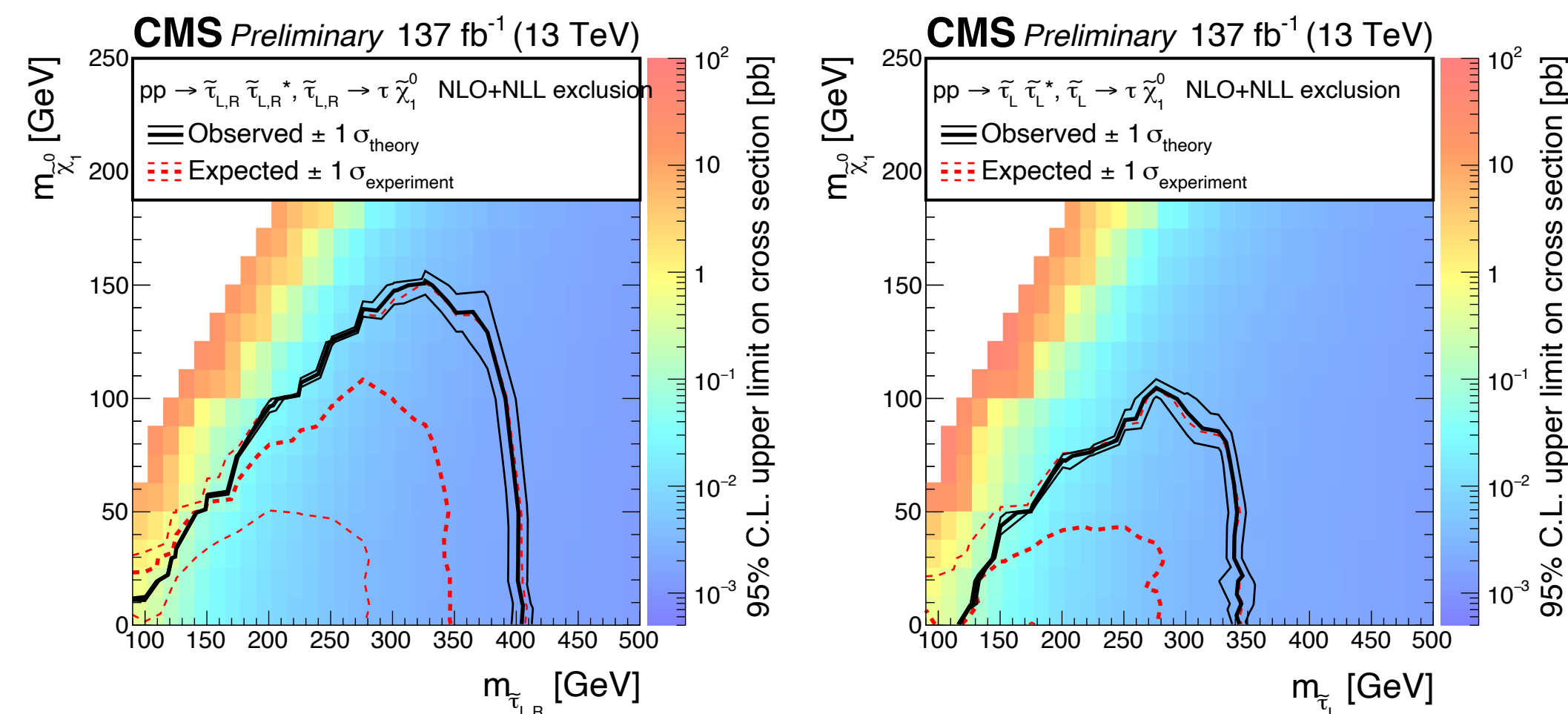
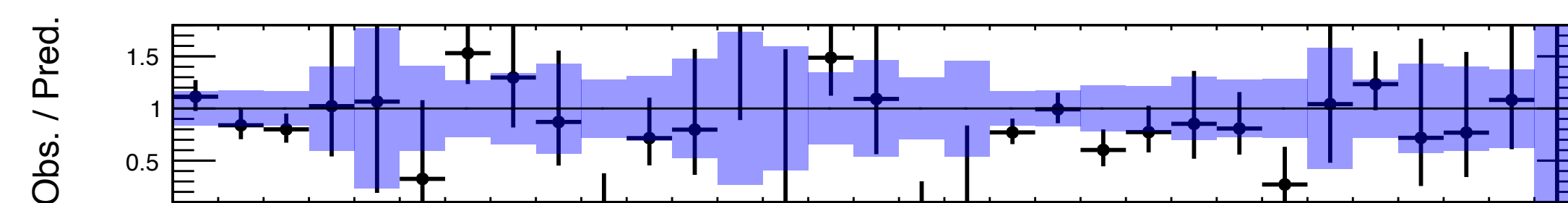
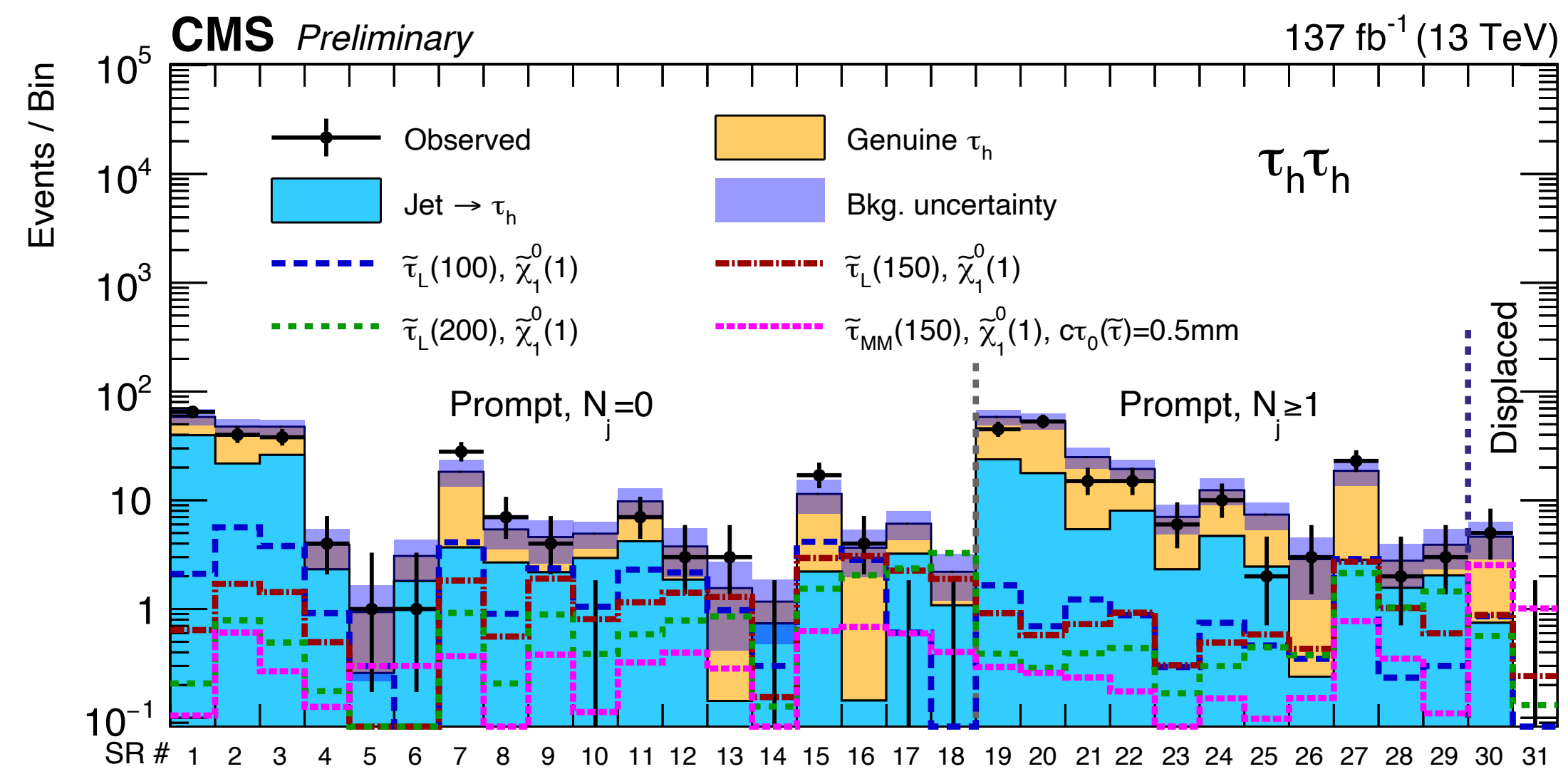

Chargino Searches

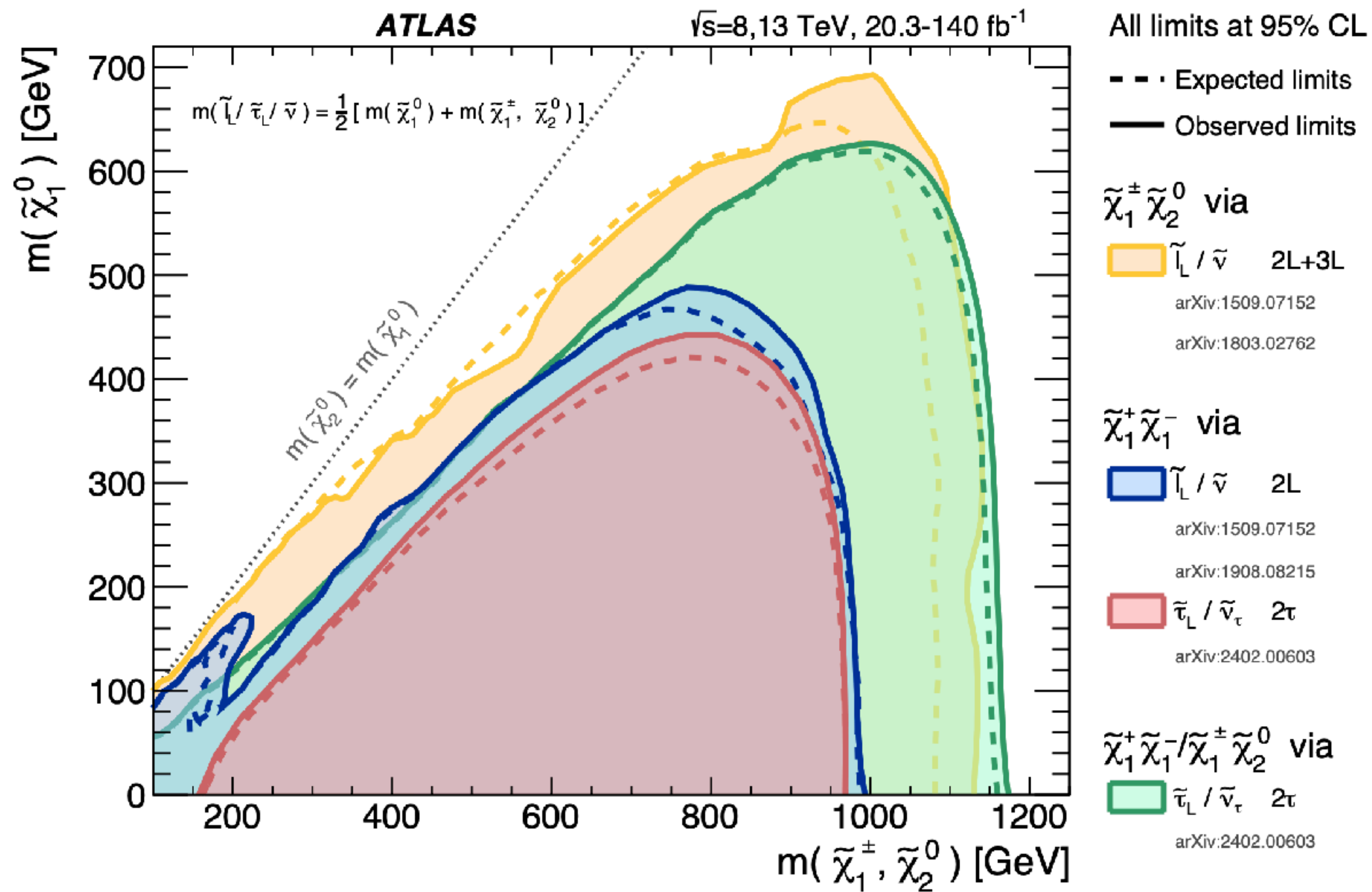

MSSM Higgs Sector Searches

- Remember MSSM requires 2 Higgs superfields \rightarrow several neutral Higgs (h, H, A)
 - Masses of all 5 Higgs bosons are set by the masses of the known gauge bosons and 2 additional parameters; normally take: $m_A, \tan\beta$
- All three contribute to the “Higgs to tau tau” channel:

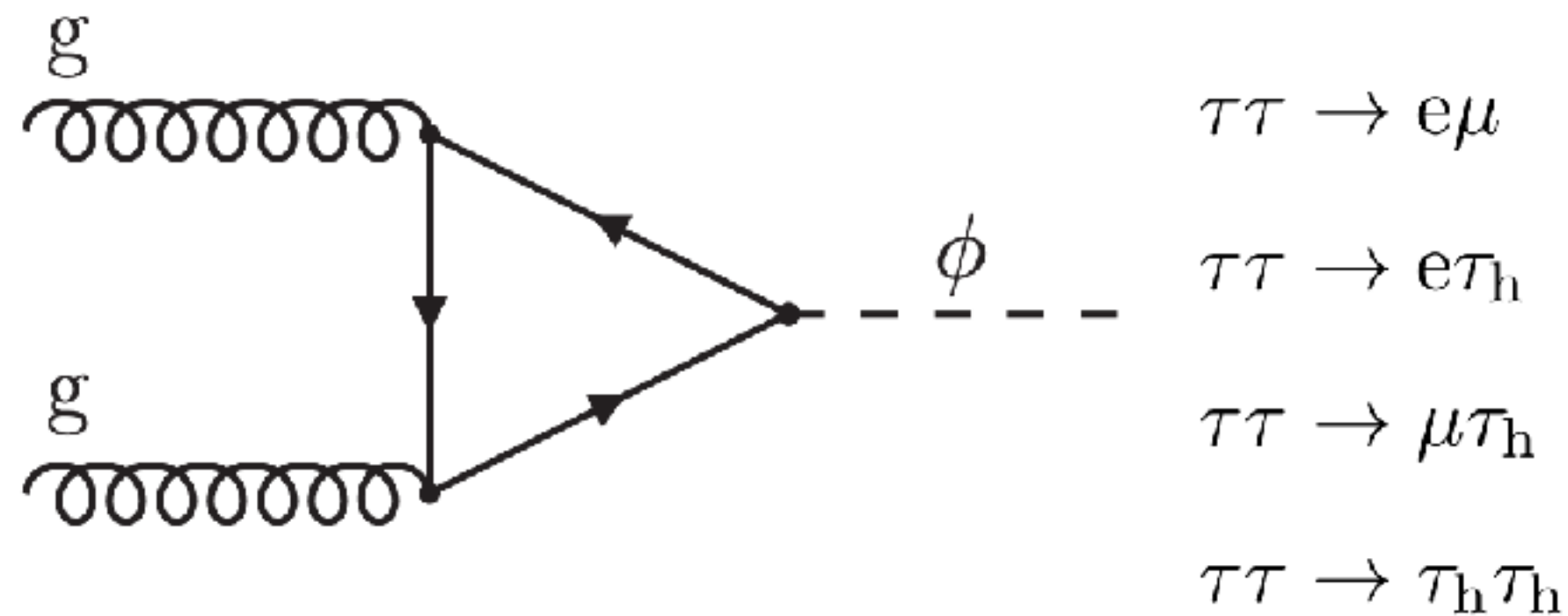

- Two 3σ excesses observed \rightarrow

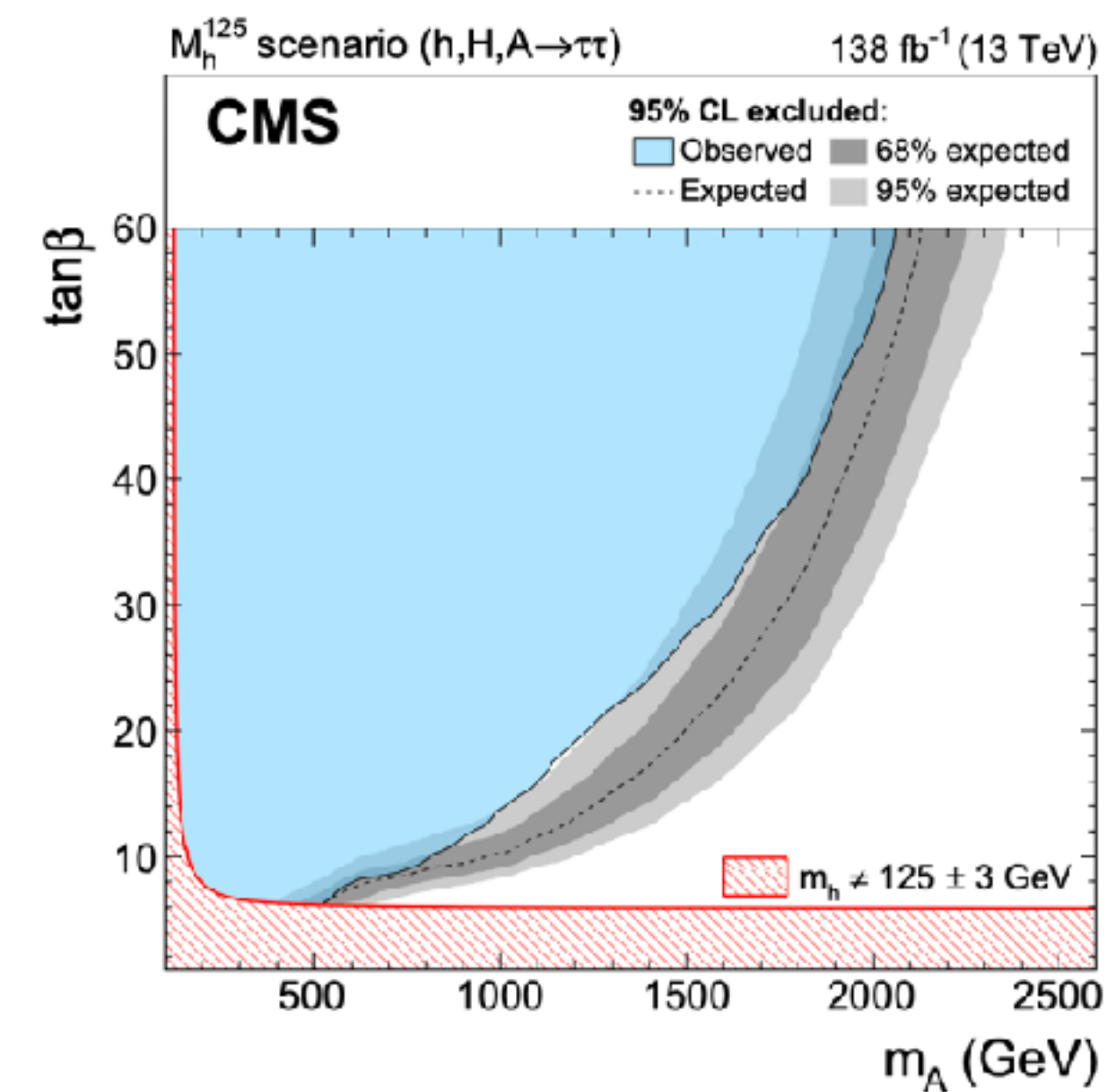
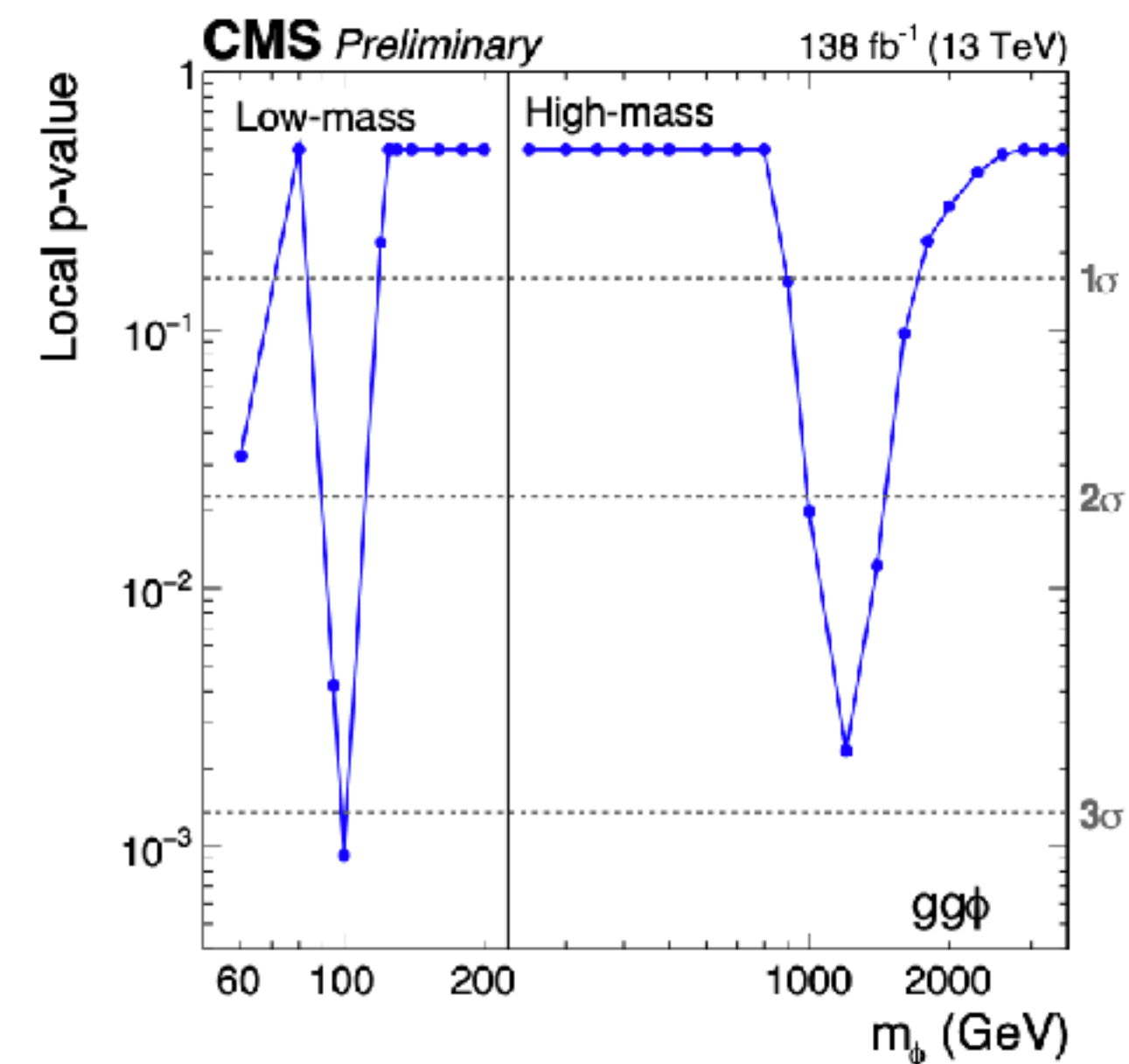

MSSM Higgs Sector Searches

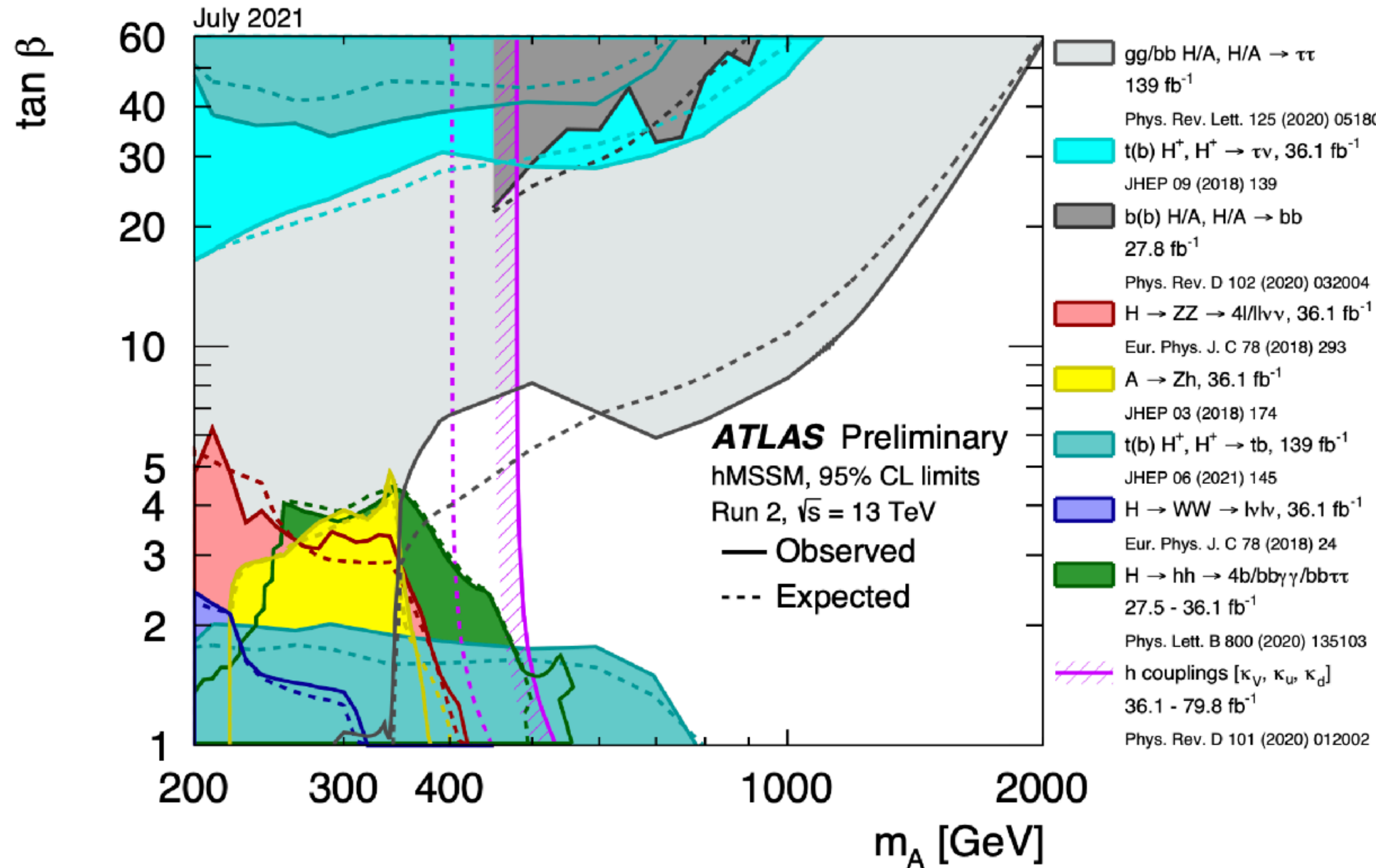

Conclusion

- Vast amount of physics analyses in search of Supersymmetry
- Cover many different scenarios (choose your favorite)
- No evidence of SuSy

For latests results:

- CMS: <https://twiki.cern.ch/twiki/bin/view/CMSPublic/PhysicsResultsSUS>
- Atlas: <https://twiki.cern.ch/twiki/bin/view/AtlasPublic/SearchesPublicResults>