

Knowledge Transfer and Innovation (KTI) @ IGFAE

A short review

Pablo Cabanelas
IGFAE

14/04/2023

Mission: help scientific talent to translate their knowledge and lab discoveries into value

KTI is about impact, not income!!!!

Technology Transfer Options For **Scientists**

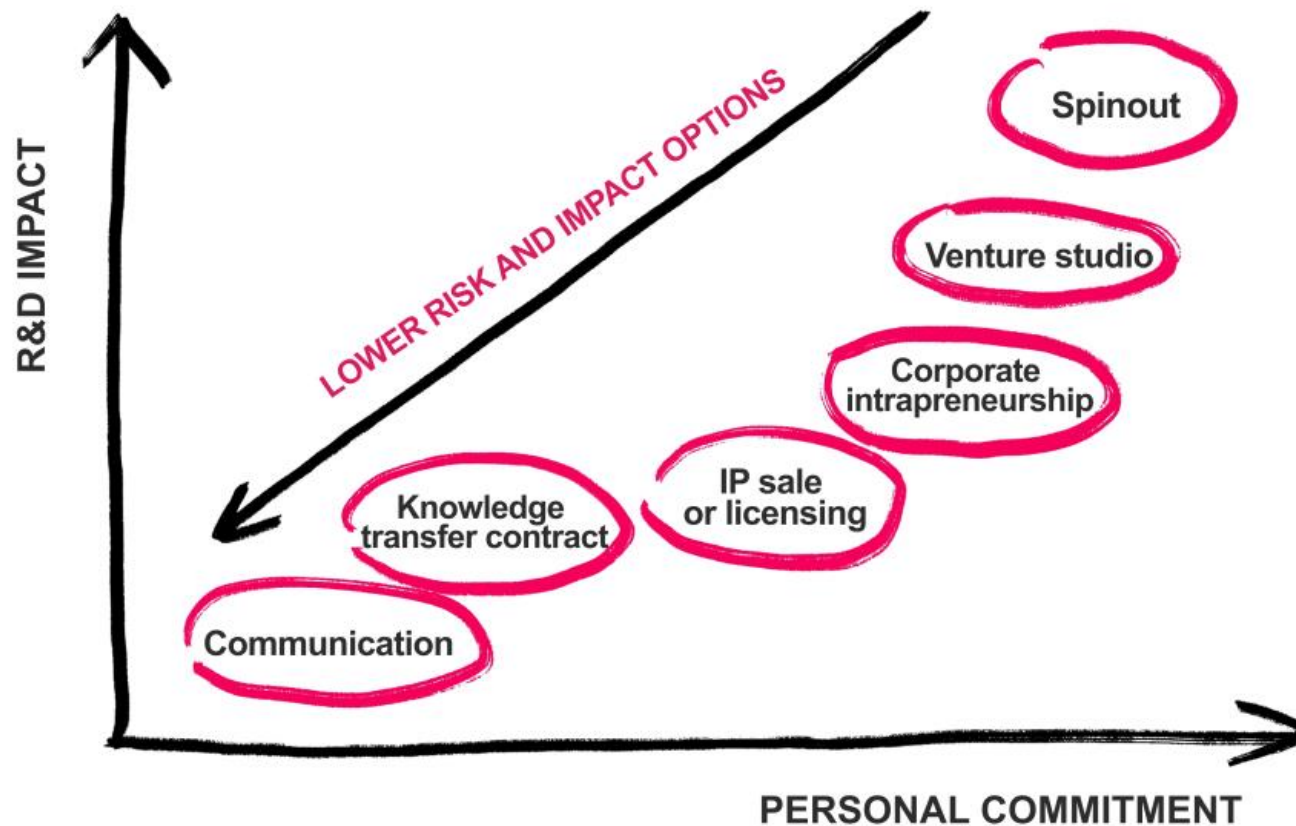

Much more than spin-offs!!



Spin-offs



Spin-offs and Venture capitals and accelerators

Start-up accelerators

Technology Transfer Options For Scientists

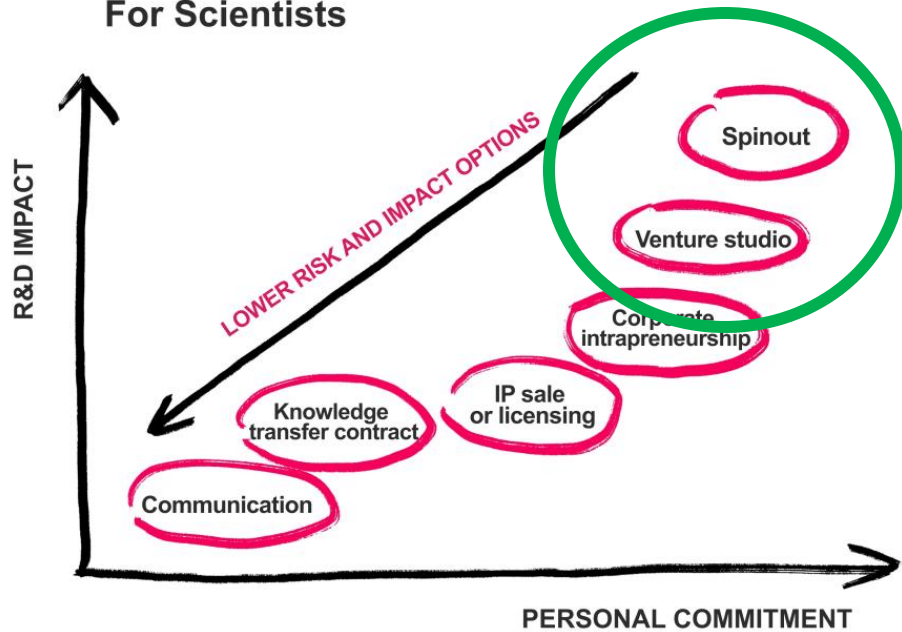

Venture capitals



SEMOLA Tech Ventures



Data analytics

Corporate intrapreneurship

Doutoramento Industrial

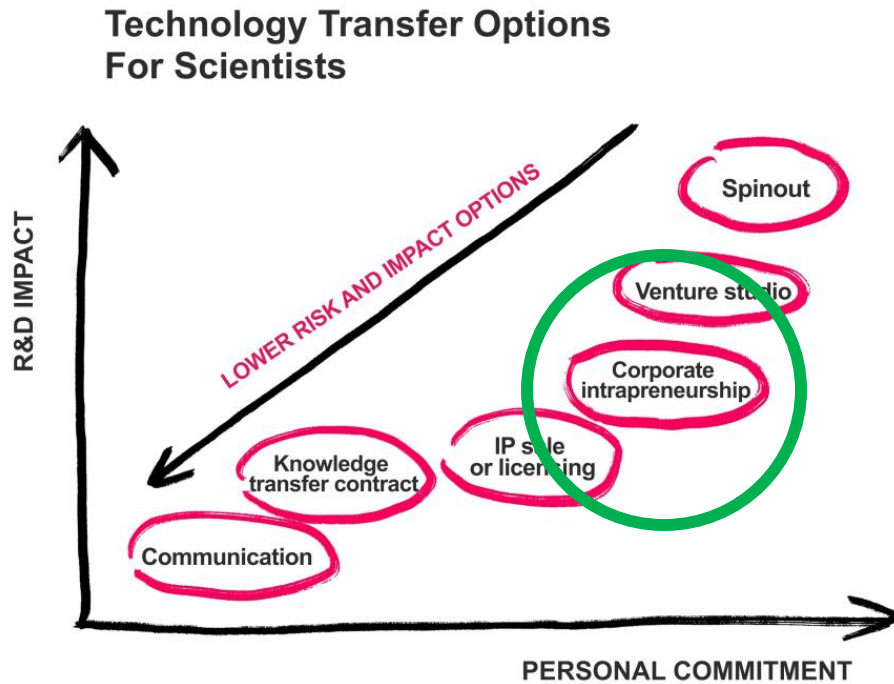

Analytics-Driven Decisions.

Consultants



Tecnological foudantion

Companies are continuously searching for new technologies that they can use to build innovative products.

IP management

Technology Transfer Options For Scientists

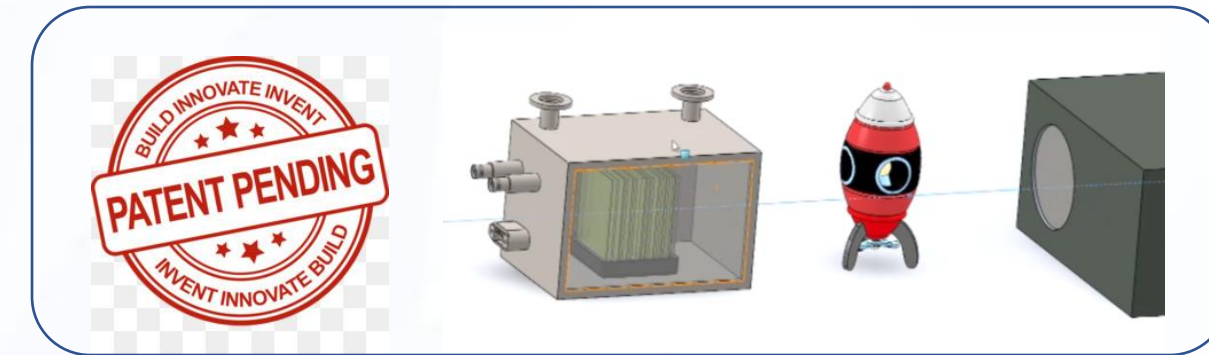
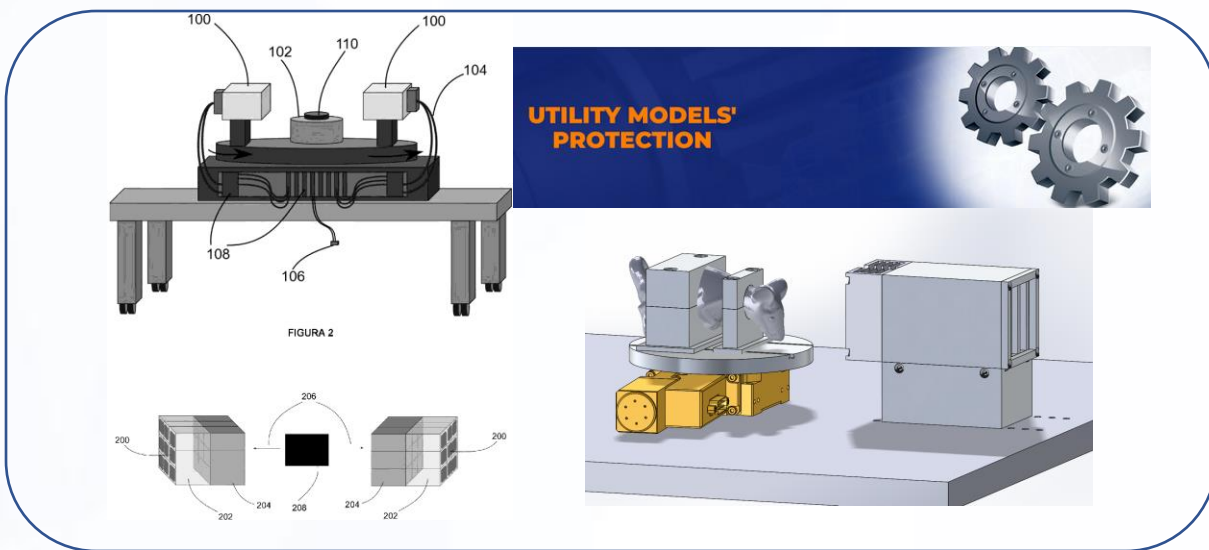
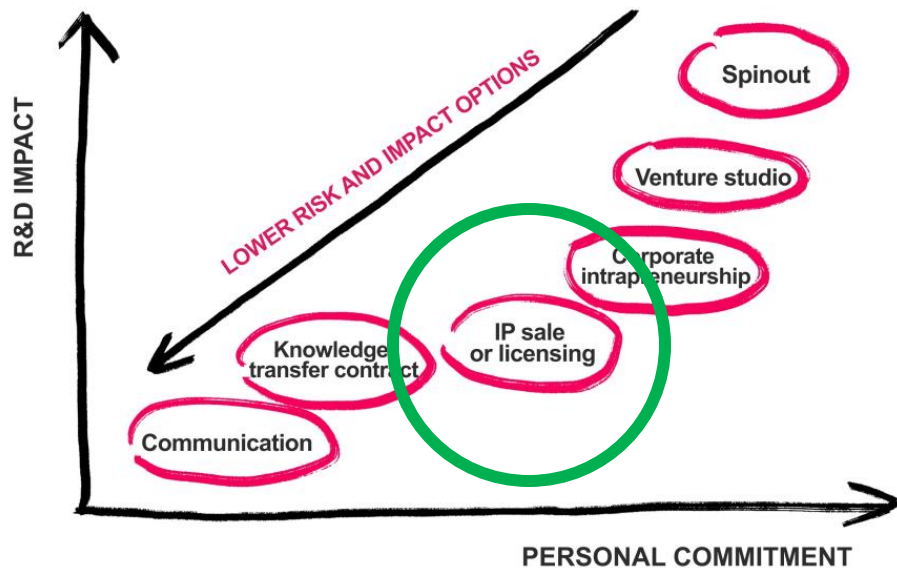

Companies are continuously searching for new technologies that they can use to build innovative products.

IP management

Technology Transfer Options For Scientists

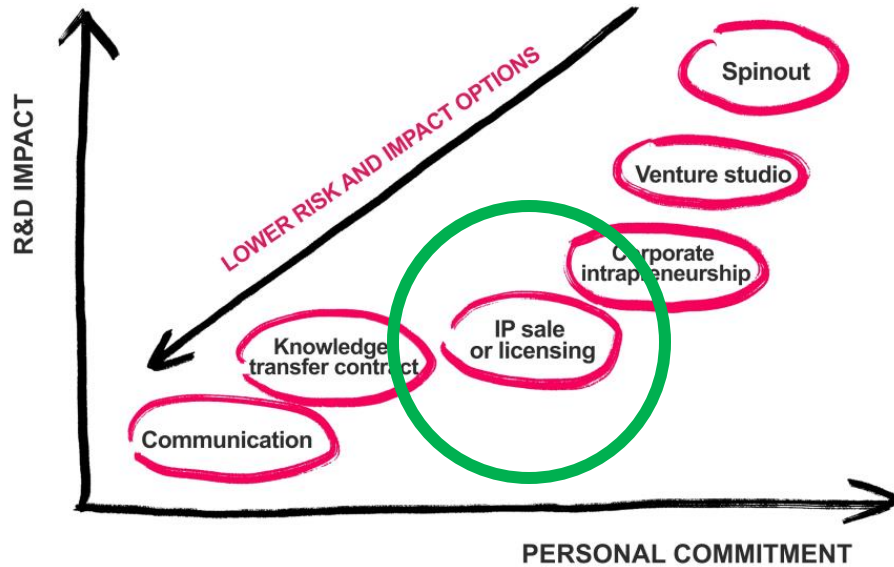

O Fiouco - Cámara de néboa



MAKERGAL



Not yet have transferable IP

Share what we know and work together!

Knowledge transfer contract



Research agreement

Technology Transfer Options For Scientists

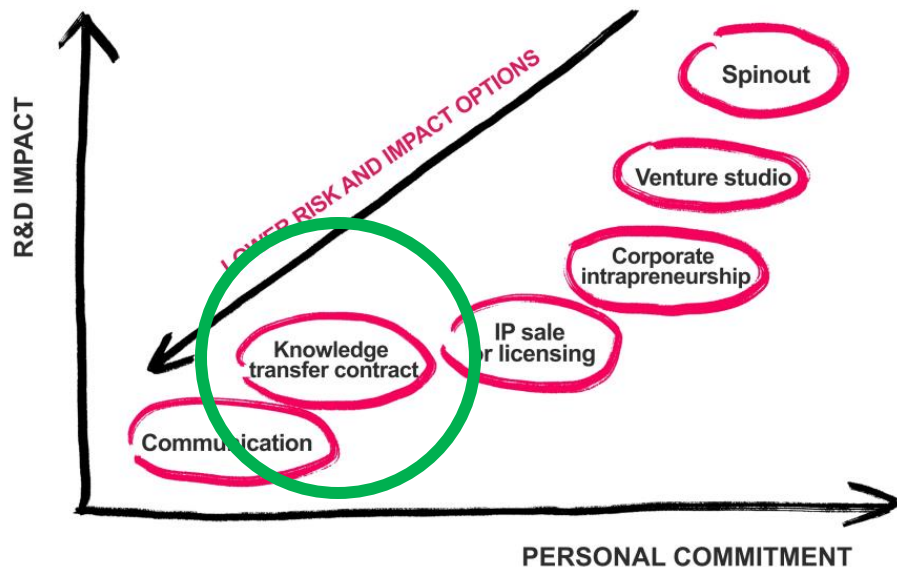

Research agreement + NDA

**+ papers,
conferences, etc.**

Communication



Technology Transfer Options For Scientists

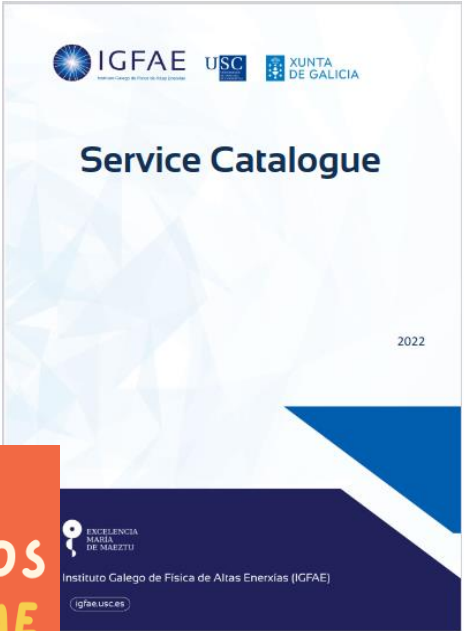
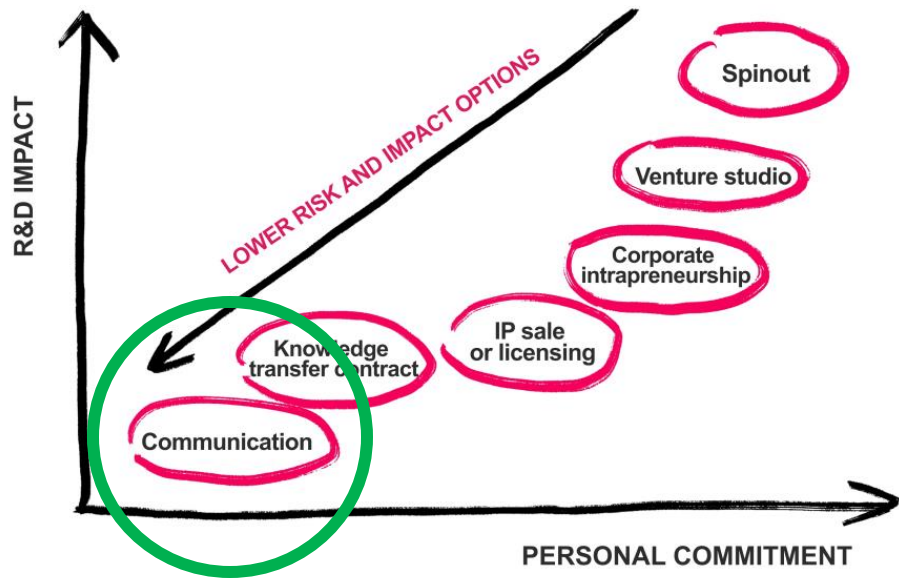

Innovation and transfer oriented research proposals

European Innovation Council
EIC Pathfinder
Support to research teams to research or develop an emerging breakthrough technology



Technology Transfer Options For Scientists

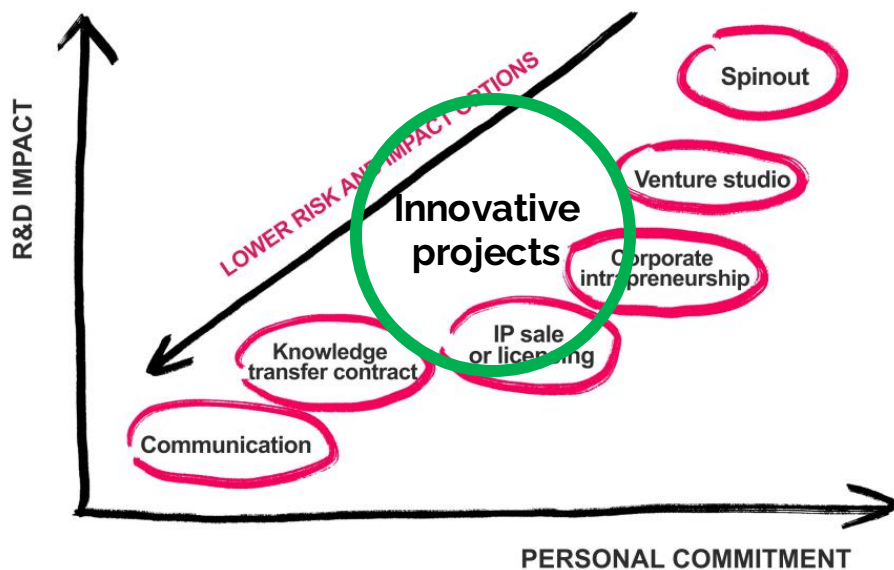

Programa de investigación - Convocatoria 2023

Subvenciones para la realización de proyectos de investigación científica en la Red de Parques Nacionales

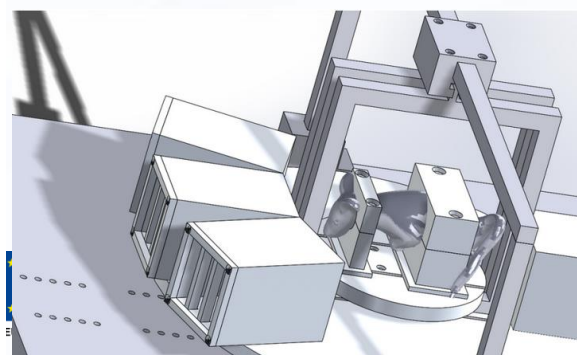

Proyectos de «Prueba de Concepto» 2022

Any action is one step towards closing transfer and innovation gap

Technology Transfer Options For Scientists

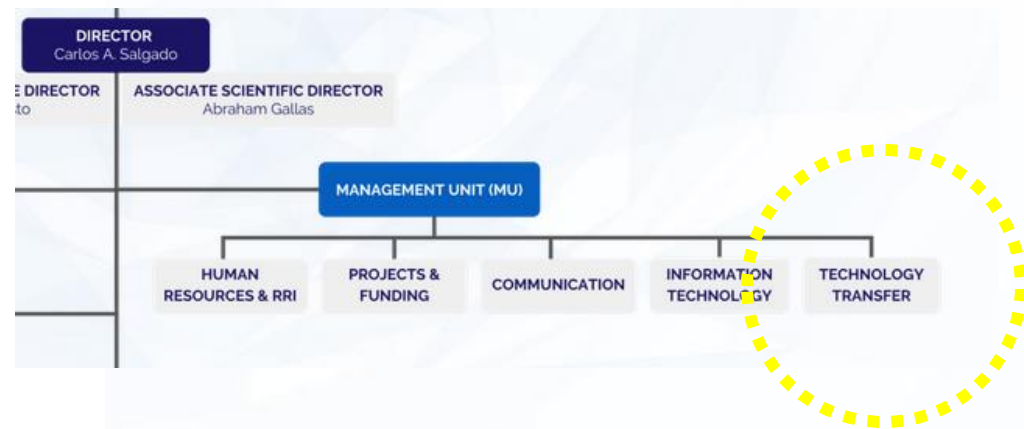
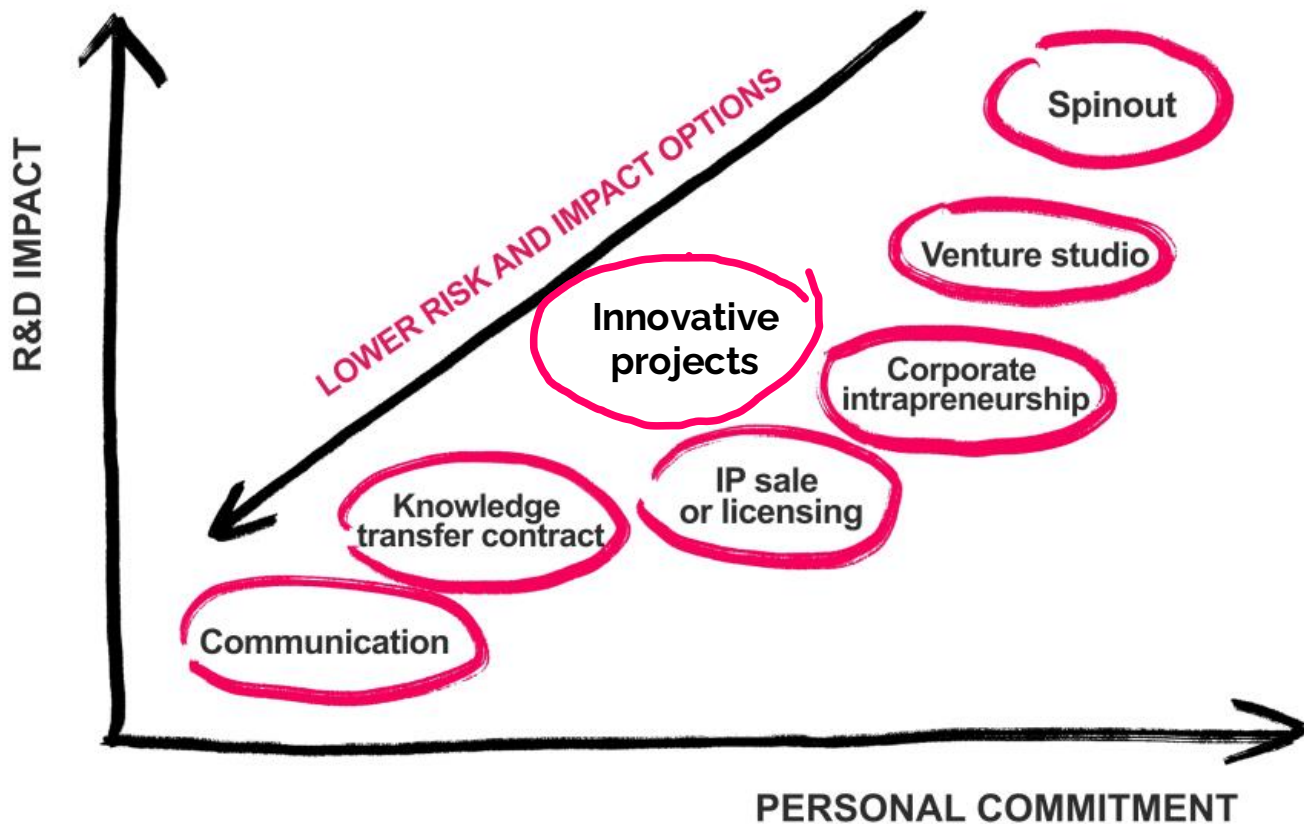

For KTT inquiries, contact the Innovation Knowledge and Technology Transfer Officer, Pablo Cabanelas, in:

Email: pablo.cabanelas@usc.es

Tel: +34881813636