

Dark Matter

Paulo Brás
Internship Program 2022

Gravitational Anomalies and Missing Mass

In 1933, **Fritz Zwicky** noticed a large discrepancy in the mass of the **Coma cluster** when calculated using galactic motion or luminosity.

$$\frac{M_{\text{Virial}}}{M_{\odot}} = 4.5 \times 10^{13} M_{\odot} \quad ; \quad M_{\text{L}} \approx 2.6 \times 10^{11} M_{\odot}$$

He proposed that some form of non-luminous matter was responsible for binding the cluster together, calling it “**dark matter**”.

This **dark matter** could not emit or absorb radiation, and should be ~200 times more abundant than regular (baryonic) matter.

One year before, **Jan Oort** pointed that additional mass was necessary to explain the motion of stars in our neighbourhood (interstellar gas!).

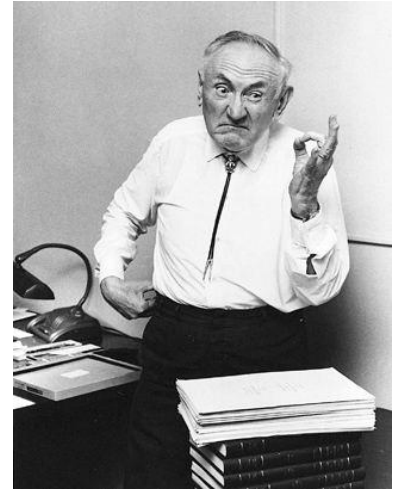

A very upset Fritz
Zwicky

Gravitational Anomalies and Missing Mass

The pioneer work of **Vera Rubin** on **galaxy rotation curves** also uncovered a discrepancy between most observations and the expected from Newtonian dynamics:

The velocity of stars remained **approx. constant** at large radii.

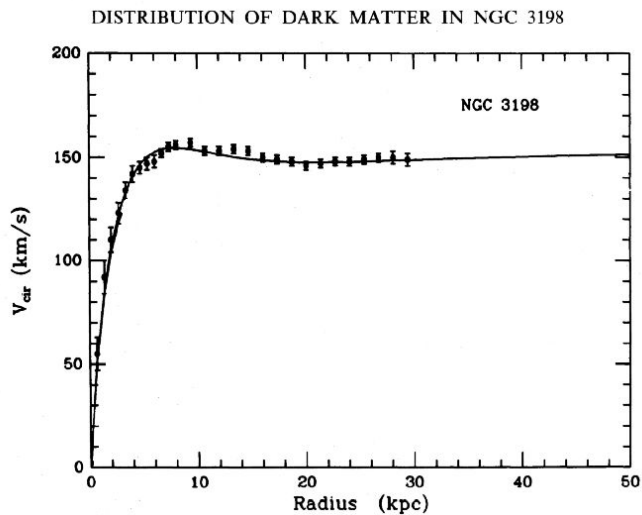

Vera Rubin

Sim. of observed rotation of galaxies, credit: [Ingo Berg](#)

Gravitational Anomalies and Missing Mass

The pioneer work of **Vera Rubin** on **galaxy rotation curves** also uncovered a discrepancy between most observations and the expected from Newtonian dynamics:

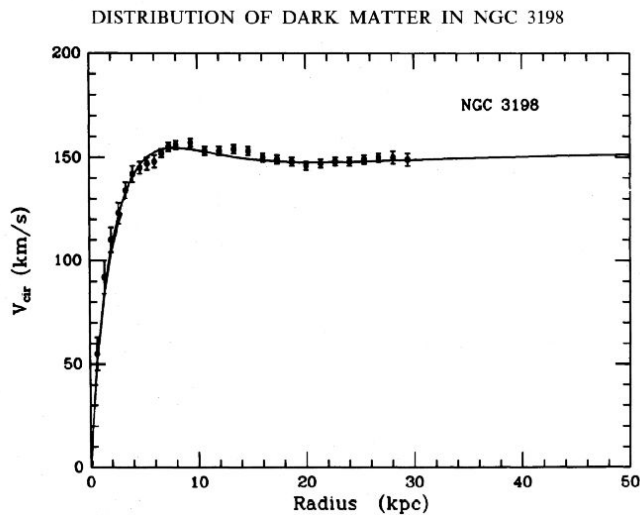

The velocity of stars remained **approx. constant** at large radii.

Two possible explanations:

1. Newtonian dynamics is insufficient
2. **There is missing mass in the system**



Vera Rubin

Gravitational Anomalies and Missing Mass

The pioneer work of **Vera Rubin** on **galaxy rotation curves** also uncovered a discrepancy between most observations and the expected from Newtonian dynamics:

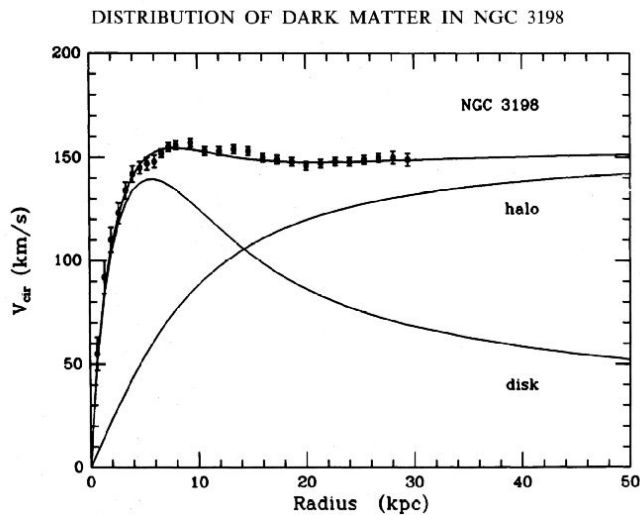

The velocity of stars remained **approx. constant** at large radii.

Missing mass problem

A **dark matter halo** envelops the galaxy and reaches far beyond the galactic disk.



Vera Rubin

Gravitational Anomalies and Missing Mass

The pioneer work of **Vera Rubin** on **galaxy rotation curves** also uncovered a discrepancy between most observations and the expected from Newtonian dynamics:

The velocity of stars remained **approx. constant** at large radii.

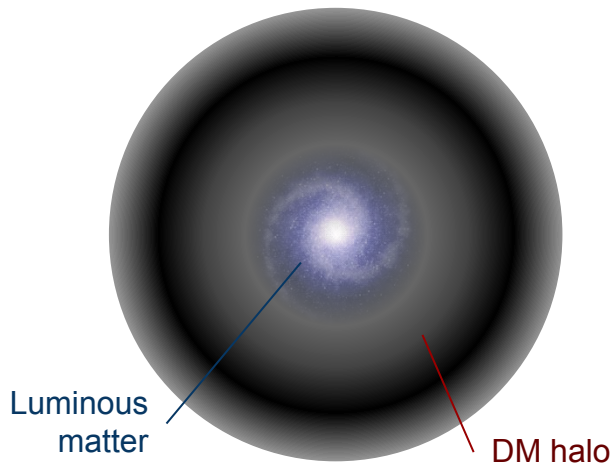

Missing mass problem

A **dark matter halo** envelops the galaxy and reaches far beyond the galactic disk.

Our Milky Way halo is expected to compose ~88.5% of its total mass!



Vera Rubin

Other Gravitational Effects

Gravitational Lensing

The presence of a massive object generates local distortions of space-time (General Relativity).

If the massive object is in the optical path of distant light sources, it will distort their image.

1. Strong lensing (a)
2. Weak lensing (b)

The amount of distortion in space-time correlates to the total mass of the object!

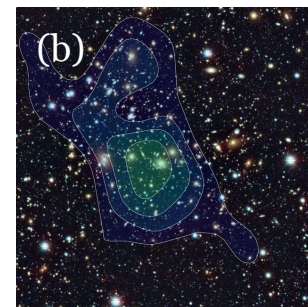
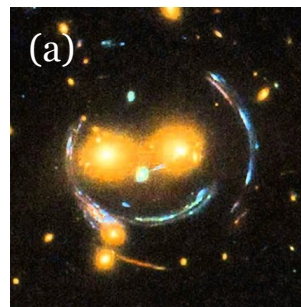
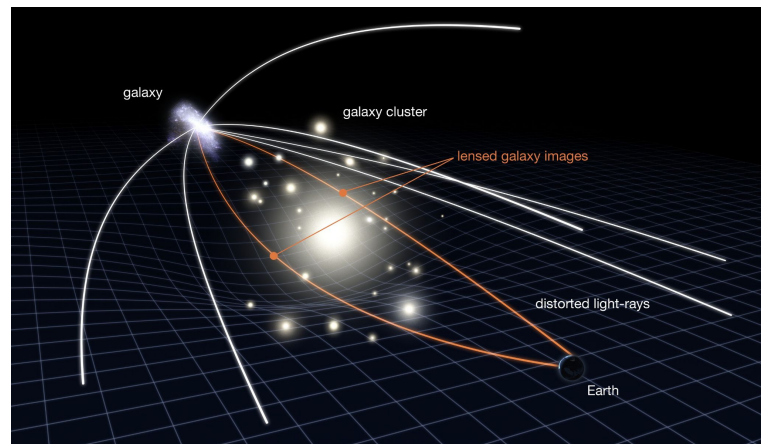

Other Gravitational Effects

Gravitational Lensing

The presence of a massive object generates local distortions of space-time (General Relativity).

If the massive object is in the optical path of distant light sources, it will distort their image.

1. Strong lensing (a)
2. Weak lensing (b)

The amount of distortion in space-time correlates to the total mass of the object!



First images of JWST (12/07/2022)

Other Gravitational Effects

Gravitational Lensing - Bullet Cluster

Contributions of the [intergalactic gas](#) (pink) from its [X-rays](#) and the [majority of the matter](#) (blue) in the cluster inferred from weak gravitational lensing

The overall mass inferred from lensing cannot be completely justified by luminous (baryonic) matter.

Whatever matter comprises the majority of the mass content of the clusters **does not interact significantly with itself neither with regular matter!**

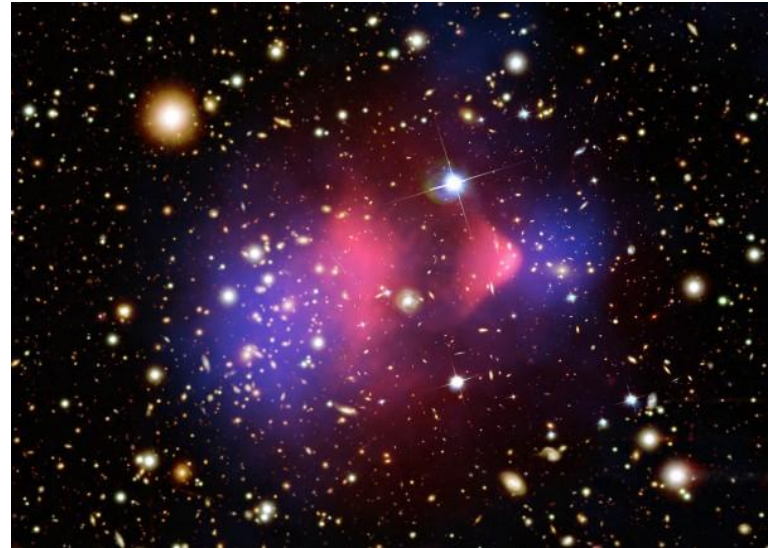

The Bullet Cluster collision (NASA)

The Cosmic Recipe

Several scientific evidences suggest that **dark matter** and **dark energy** account for roughly 95% of the total mass-energy content of the universe.

Dark matter represents 84% of all matter in the universe!

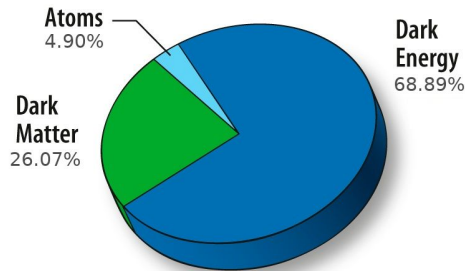

Λ - Cold Dark Matter (Λ CDM) model of the universe is the Standard Model of Cosmology.

- The dynamics and evolution of the universe is dominated by dark energy (Λ) and cold dark matter (CDM)

$$\frac{\kappa}{a^2} = H^2 (\Omega_r + \Omega_m + \Omega_\Lambda - 1).$$



$$\Omega_i = \rho_i(t) \frac{8\pi G}{3H^2}$$
$$\Omega_\Lambda = \frac{\Lambda}{3H^2}$$

Energy-density parameters

Experimental Evidences of Dark Matter

Cosmic Microwave Background (CMB)

Thermal radiation left over from the **time of last scattering**, ~ 380 thousand years after the Big Bang

Today it is composed of microwave wavelength photons with a mean temperature of 2.725 ± 0.001 K.

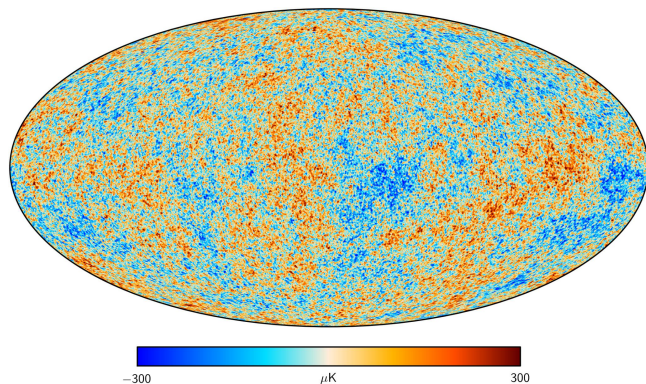

Multipole
analysis

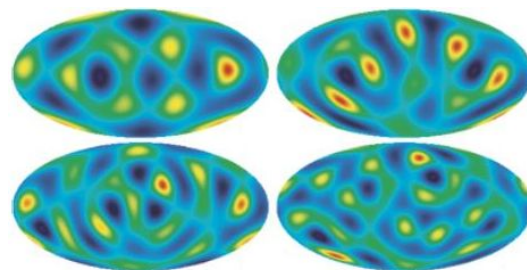
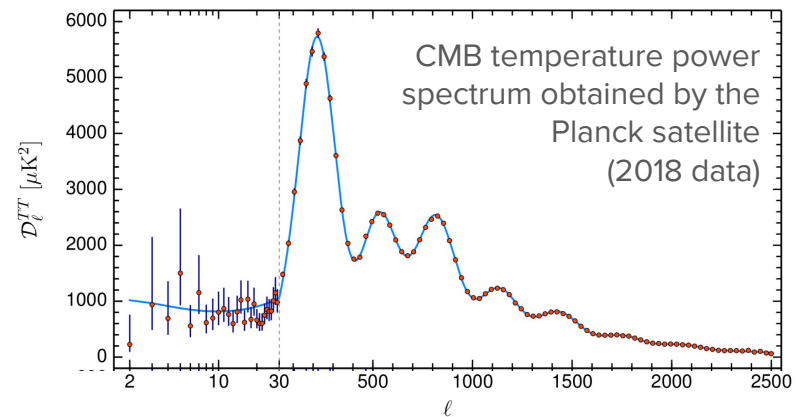

Experimental Evidences of Dark Matter

Cosmic Microwave Background (CMB)

The **fluctuations** in the CMB correspond to density variations in the primordial plasma.

The thermal anisotropies of the CMB encode the values of the **cosmological parameters!**

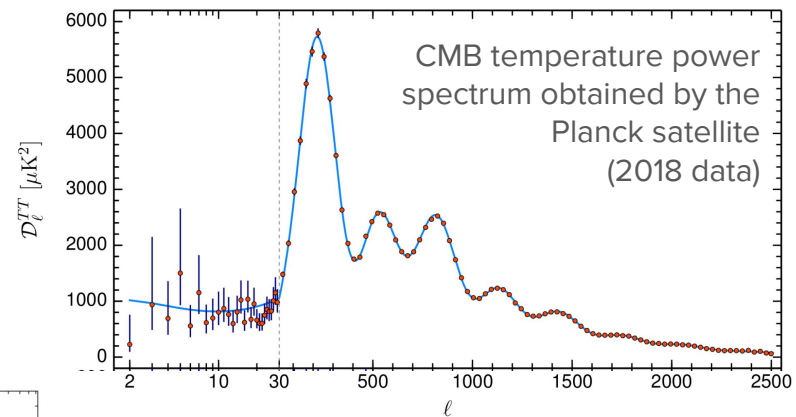
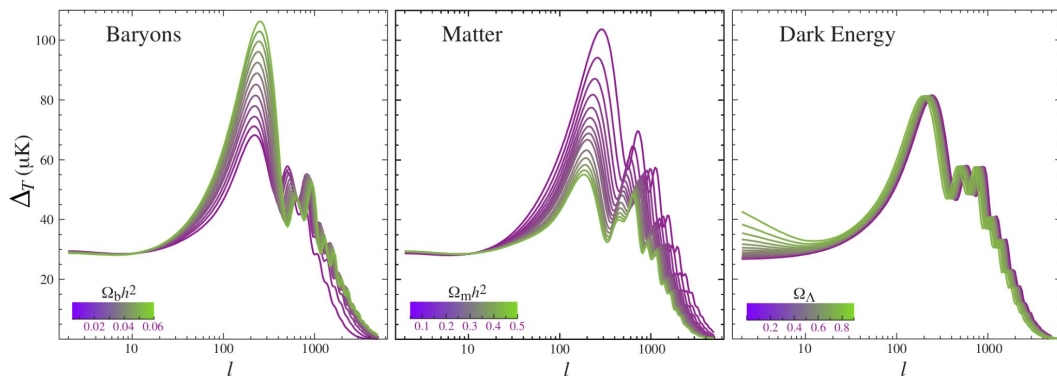

Parameter	Symbol	Value
Hubble constant [$\text{km s}^{-1} \text{Mpc}^{-1}$]	H_0	67.66 ± 0.42
Baryon energy density	$\Omega_b h^2$	0.02242 ± 0.00014
Cold Dark Matter energy density	$\Omega_c h^2$	0.11933 ± 0.00091
Total matter energy density	Ω_m	0.3111 ± 0.0056
Dark energy density	Ω_Λ	0.6889 ± 0.0056
Curvature	$\Omega_{\kappa,0}$	0.0007 ± 0.0019
Sum of neutrino masses [eV]	$\sum m_\nu$	< 0.12
Age of the universe [Gy]		13.787 ± 0.020

Experimental Evidences of Dark Matter

Baryon Acoustic Oscillations (BAO)

Pressure waves in the primordial plasma that seeded the formation of cosmological structures.

1. A photon-baryon plasma pressure wave travels outwards.
2. When photons and baryons decouple the pressure is relieved and the baryons stall.
3. Over time, dark matter and baryonic matter coalesce, leaving a peak at the sound horizon.
4. Measurement of matter distribution (galaxies and intergalactic gas) reveal the BAO peak.

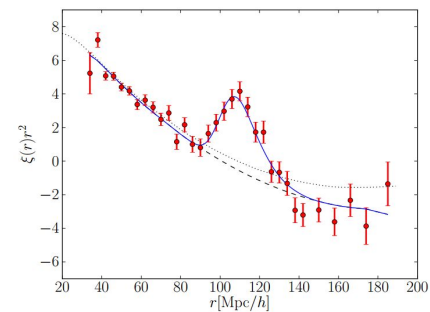
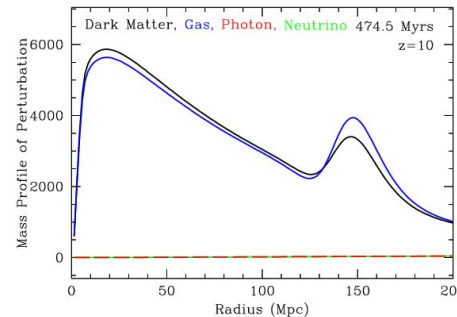
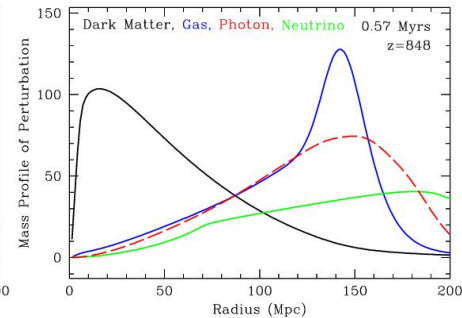
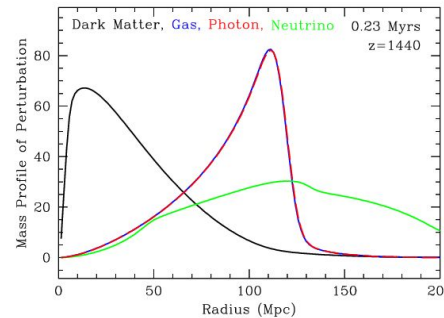

Experimental Evidences of Dark Matter

Big Bang Nucleosynthesis (BBN)

The production of light elements seconds after the Big Bang through a chain of reactions.

Sensitive to the baryon-to-photon ratio, η , that in turn informs about the total baryon density Ω_b .

$\Omega_m \approx 0.3$ from CMB data

$\Omega_b \approx 0.048$ from BBN data

This means that the vast majority of the matter in the universe **is non-baryonic in nature!**

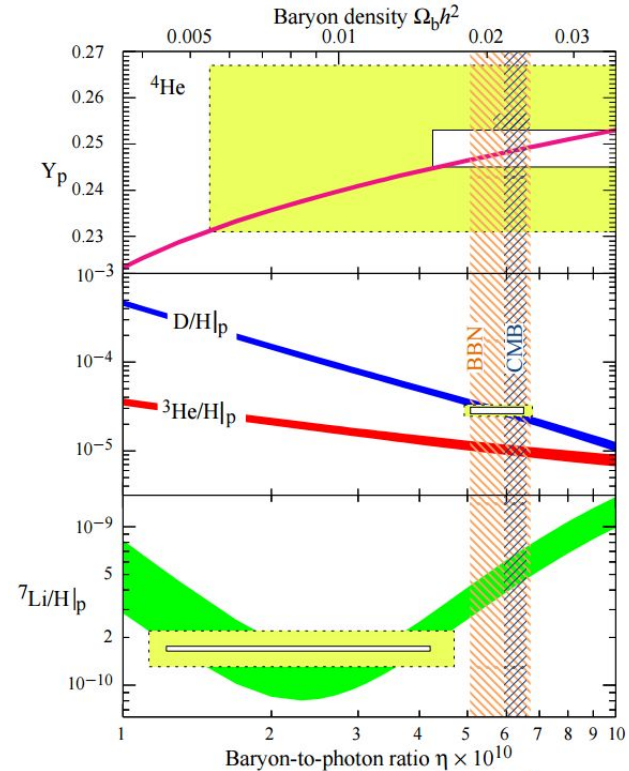

Large Scale Structures

Simulation models of structure formation are used to determine the conditions and cosmological parameters needed to reproduce the observed large scale structure of the universe.

Agreement with a dominating **weakly-interacting Cold Dark Matter (CDM)** component.

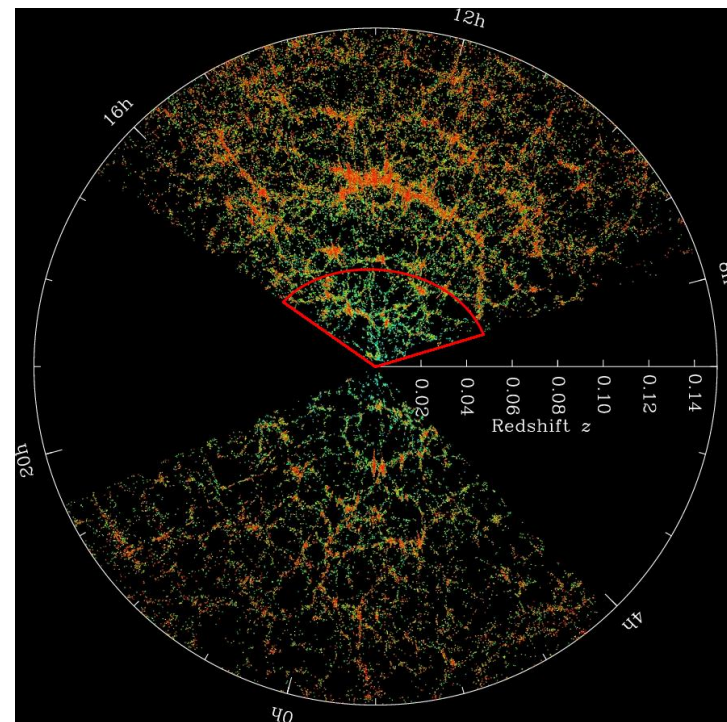
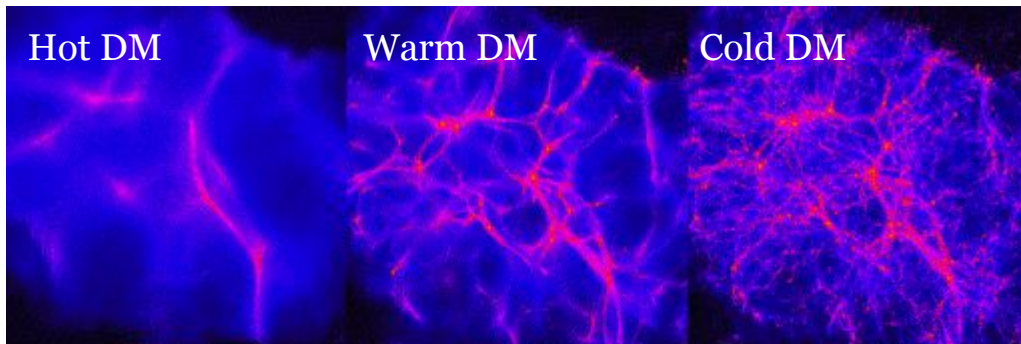

Large-scale structures of galaxies from the Sloan Digital Sky Survey

The Agreement of the Different Evidences

So far, all evidences strongly agree with the existence of dark matter and support the Λ CDM model of the universe.

Figure: how well the Λ CDM fits observations.

- Data compatible with $\Omega_\Lambda > 0$ (dark energy dominated)
- Supernova (SNe) surveys determine the acceleration history of the universe.

Most recent estimates from CMB and Cepheid variables present some tension on the current expansion rate H_0

Agreement between data from SNe Ia, CMB and BAO data prior to 2012, over the $\Omega_m - \Omega_\Lambda$ phase-space

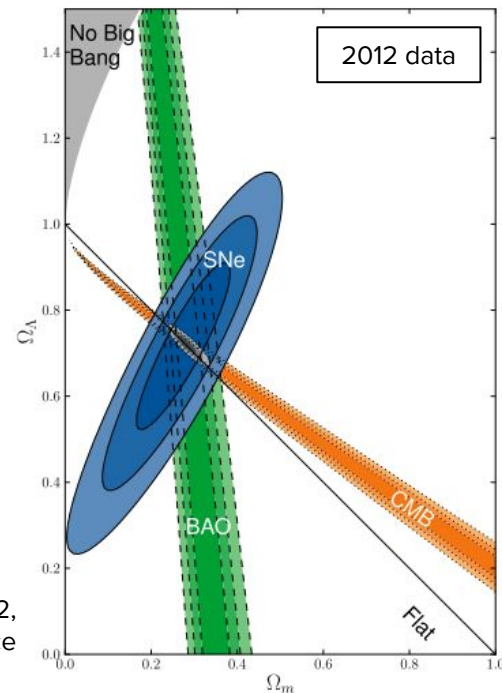

The Agreement of the Different Evidences

So far, all evidences strongly agree with the existence of dark matter and support the Λ CDM model of the universe.

Figure: how well the Λ CDM fits observations.

- Data compatible with $\Omega_\Lambda > 0$ (dark energy dominated)
- Supernova (SNe) surveys determine the acceleration history of the universe.

Most recent estimates from CMB and Cepheid variables present some tension on the current expansion rate H_0

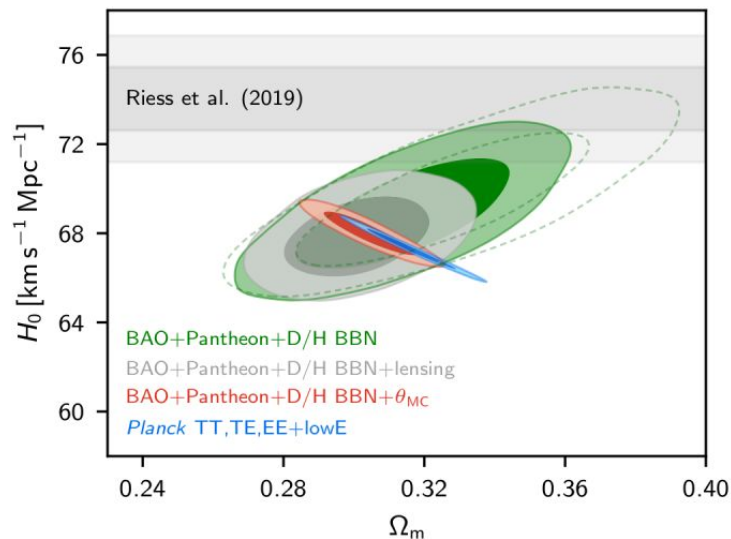

Agreement between data from Planck CMB, BAO and BBN data (2021), over the $\Omega_m - H_0$ phase-space

What is Dark Matter?

Hypothetical “substance” that is **massive, long-lived, chargeless and weakly-interacting** with itself and other matter.

What dark matter is not:

Standard Model of Elementary Particles

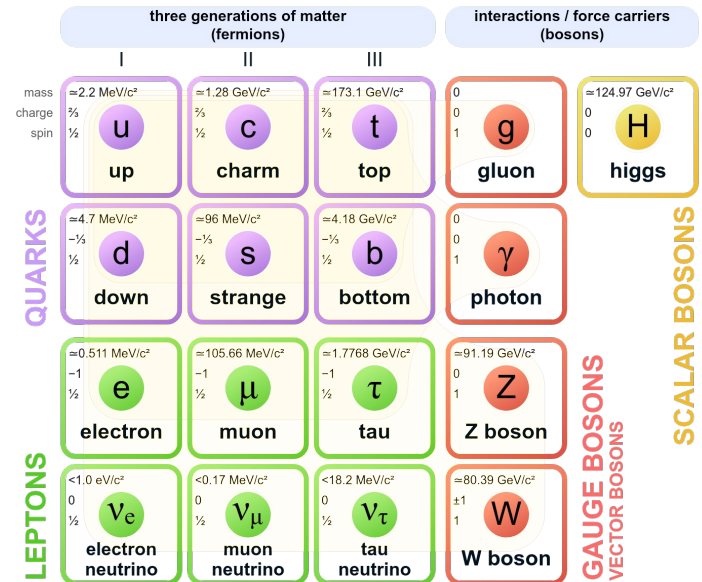

What is Dark Matter?

Hypothetical “substance” that is **massive, long-lived, chargeless and weakly-interacting** with itself and other matter.

What dark matter is not:

- Photons

Standard Model of Elementary Particles

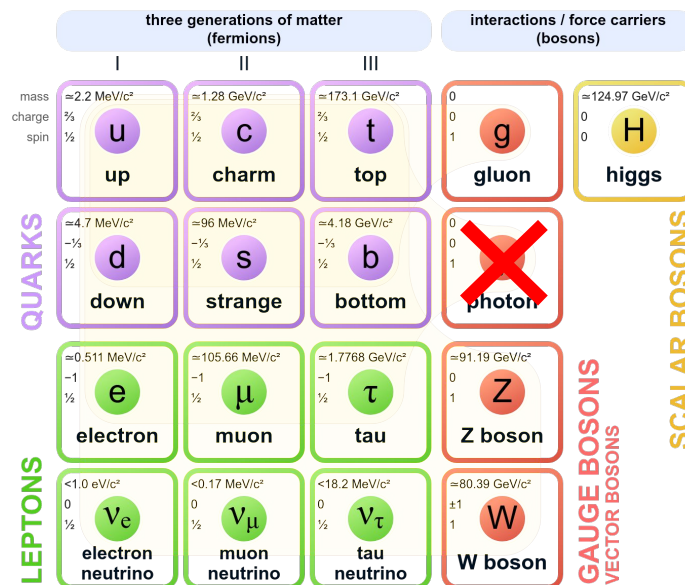

What is Dark Matter?

Hypothetical “substance” that is **massive, long-lived, chargeless and weakly-interacting** with itself and other matter.

What dark matter is not:

- Photons
- Quarks, Gluons

Standard Model of Elementary Particles

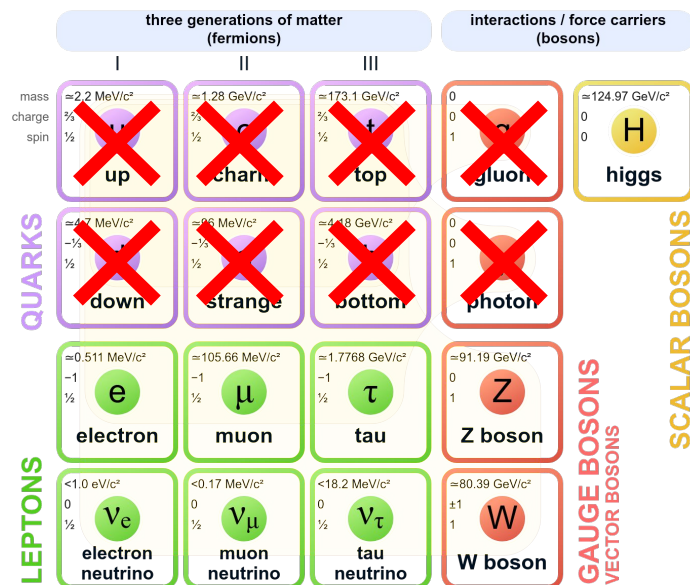

What is Dark Matter?

Hypothetical “substance” that is **massive, long-lived, chargeless and weakly-interacting** with itself and other matter.

What dark matter is not:

- Photons
- Quarks, Gluons
- Charged leptons

Standard Model of Elementary Particles

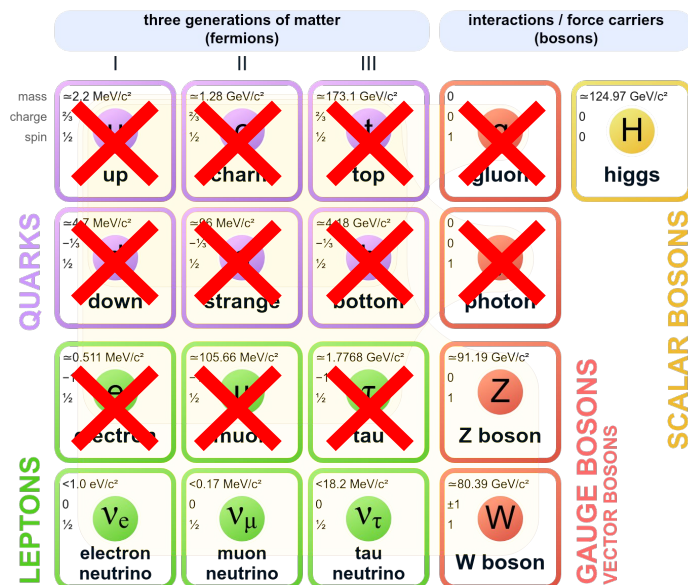

What is Dark Matter?

Hypothetical “substance” that is **massive, long-lived, chargeless and weakly-interacting** with itself and other matter.

What dark matter is not:

- Photons
- Quarks, Gluons
- Charged leptons
- Heavy bosons

Standard Model of Elementary Particles

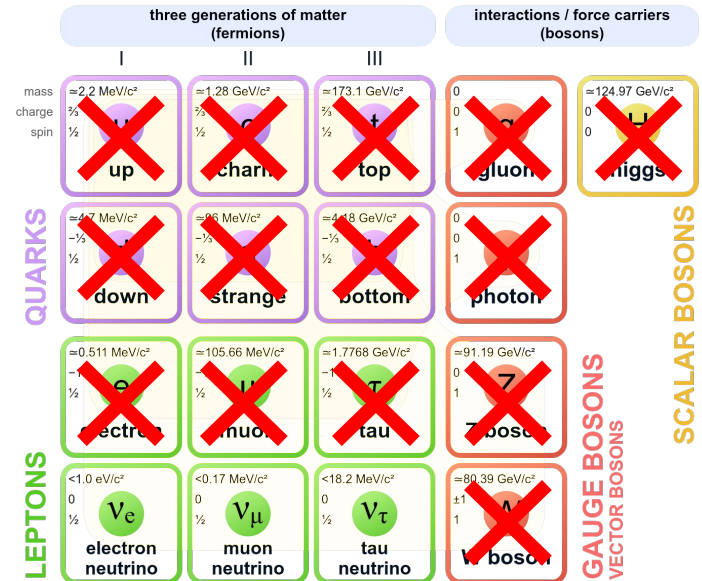

What is Dark Matter?

Hypothetical “substance” that is **massive, long-lived, chargeless and weakly-interacting** with itself and other matter.

What dark matter is not:

- Photons
- Quarks, Gluons
- Charged leptons
- Heavy bosons
- Neutrinos*

*SM neutrinos contribute to Hot Dark Matter, but cannot explain all observations.

Standard Model of Elementary Particles

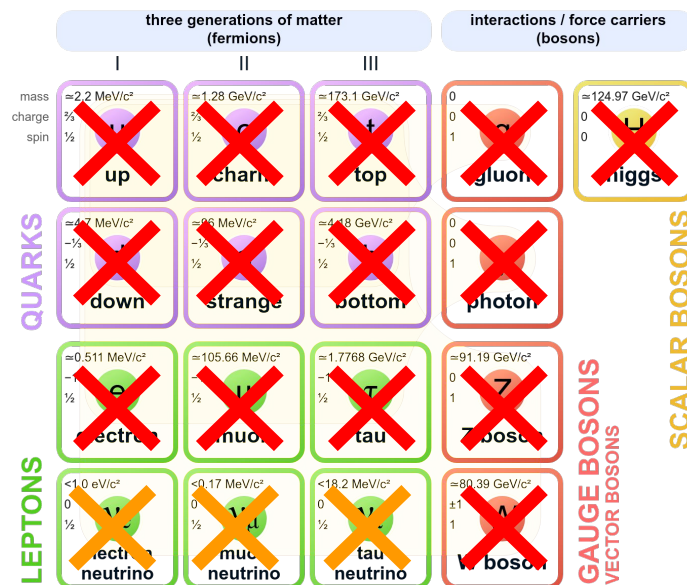

What is Dark Matter?

Hypothetical “substance” that is **massive, long-lived, chargeless and weakly-interacting** with itself and other matter.

What dark matter is not:

- Photons
- Quarks, Gluons
- Charged leptons
- Heavy bosons
- Neutrinos*

No valid candidate in the Standard Model*
Physics BSM!

*SM neutrinos contribute to Hot Dark Matter, but cannot explain all observations.

Standard Model of Elementary Particles

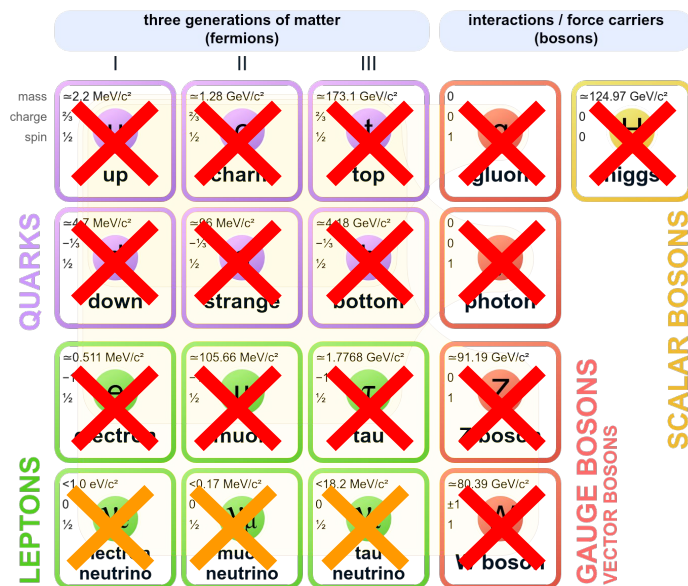

Modified Gravity?

Modification of the way gravity behaves at large scales to reproduce the observations without including unseen mass in the system.

- ❖ Accurate description of several galactic phenomena
- ❖ Doesn't exclude non-baryonic matter
- ❖ Clusters show a residual mass discrepancy
- ❖ Can't explain some gravitational lensing observations

Modifications that describe one system well seem to not explain other systems completely.

Historical precedent:

Proposed a new unseen planet beyond Uranus that could explain its orbital discrepancies.

→ **Later Neptune was discovered!**

Also proposed a new planet beyond Mercury to explain the precession of its perihelion.

→ **Solved by Einstein, that successfully modified Newton's gravity and introduced GR!**



Urbain le Verrier

Dark Matter Candidates

Pick your favourite...

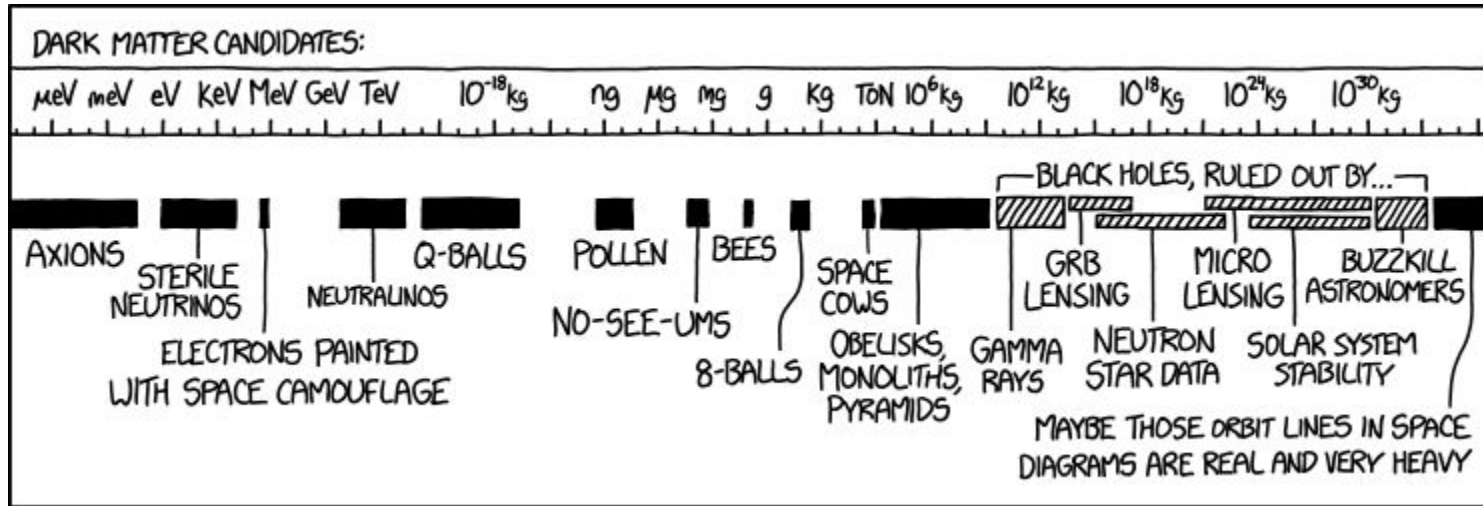

Credit: XKCD

Dark Matter Candidates

Pick your favourite...

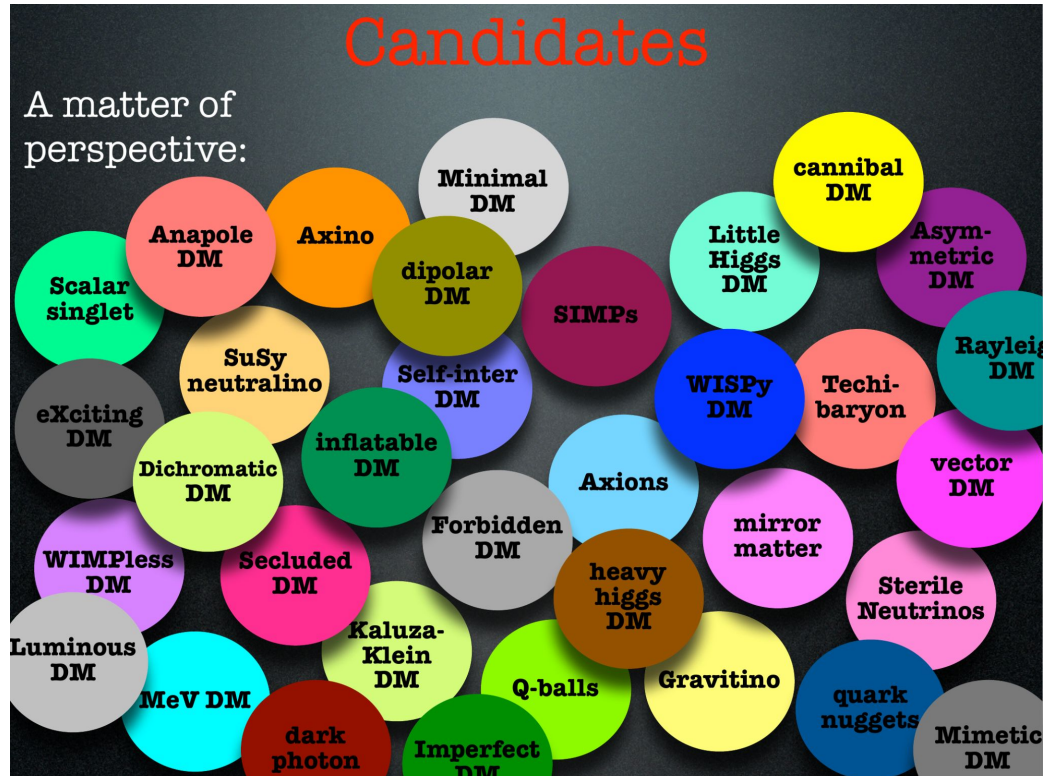

Dark Matter Candidates

MACHOs

Massive Astrophysical Compact Halo Objects, such as neutron stars, white dwarfs, brown dwarfs, Jupiter-like planets, black holes.

Mostly excluded by several evidences and surveys of microlensing and transits.

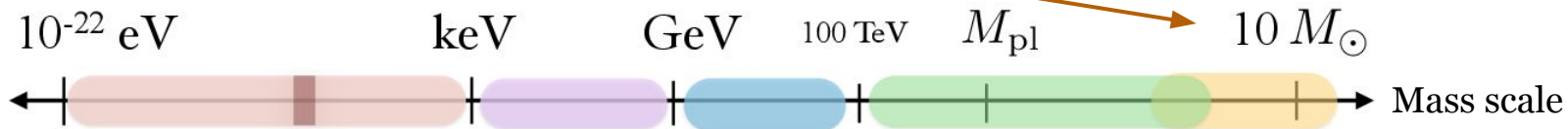

Dark Matter Candidates

Neutrinos

The most abundant particles in the universe aside from photons. Non-zero mass, weakly-interacting.

Warm or Hot Dark Matter candidates - cannot form large scale structures like the ones observed today.

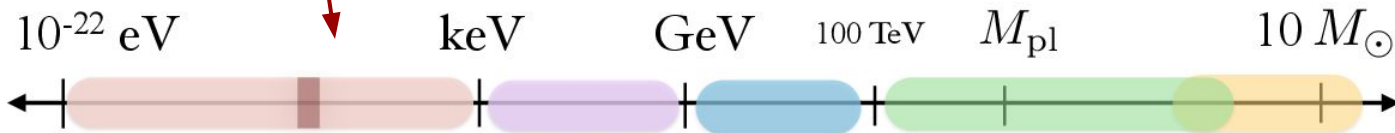
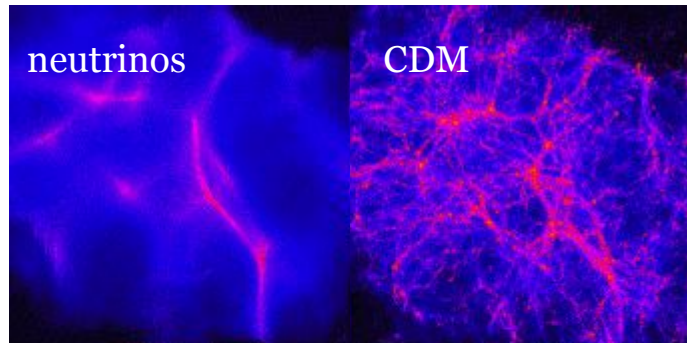

Dark Matter Candidates



Axions and Axion-like Particles (ALPs)

Hypothetical pseudoscalar particles that could justify why CP-violating processes are not observed in strong interactions (strong CP problem).

Not produced thermally (contribute to CDM).

Solves two problems with one particle!

- ❖ Axions (A^0) could convert into photons in a strong magnetic field via the Primakoff effect.
- ❖ Stellar environment can generate an axion wind (Solar axions!)
- ❖ Very low mass, more wave-like.
- ❖ Bonus: A^0 are natively predicted by String theory.

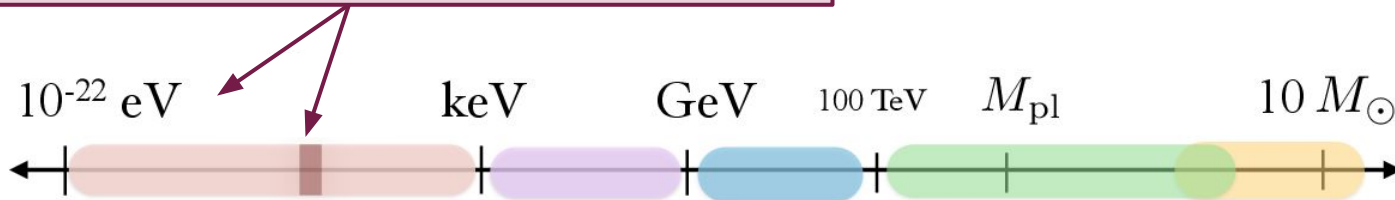

Dark Matter Candidates

WIMPs

Weakly Interacting Massive Particles, generic class of chargeless & heavy particles, produced thermally in the early universe, that provide the inferred amount of non-baryonic dark matter.

One of the strongest candidates still!

- ❖ May interact with normal matter via weak-like processes
- ❖ Consistent with BBN
- ❖ Relic abundance
- ❖ Electroweak symmetry spontaneously broken
- ❖ SUSY predicts particles with such characteristics.
 - No evidence for SUSY yet

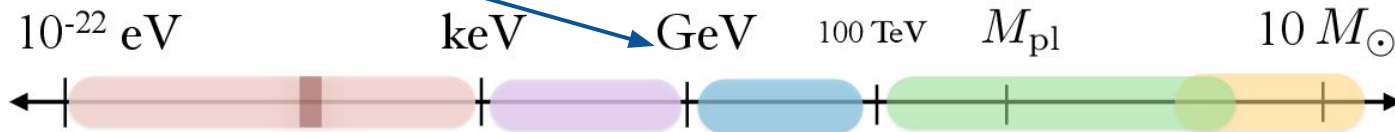

Dark Matter Candidates

Sterile Neutrinos

Hypothetical neutral heavy leptons, counterparts of “active” neutrinos, but with weak isospin = 0 (do not partake in charged weak interactions)

Can only interact via gravity or other BSM “hidden force”.

May explain the abnormally small active neutrino mass.

- ❖ Can be very heavy (eV – M_{pl})
- ❖ May mix with active neutrinos via Yukawa interactions with other leptons and the Higgs boson.



Dark Matter Candidates

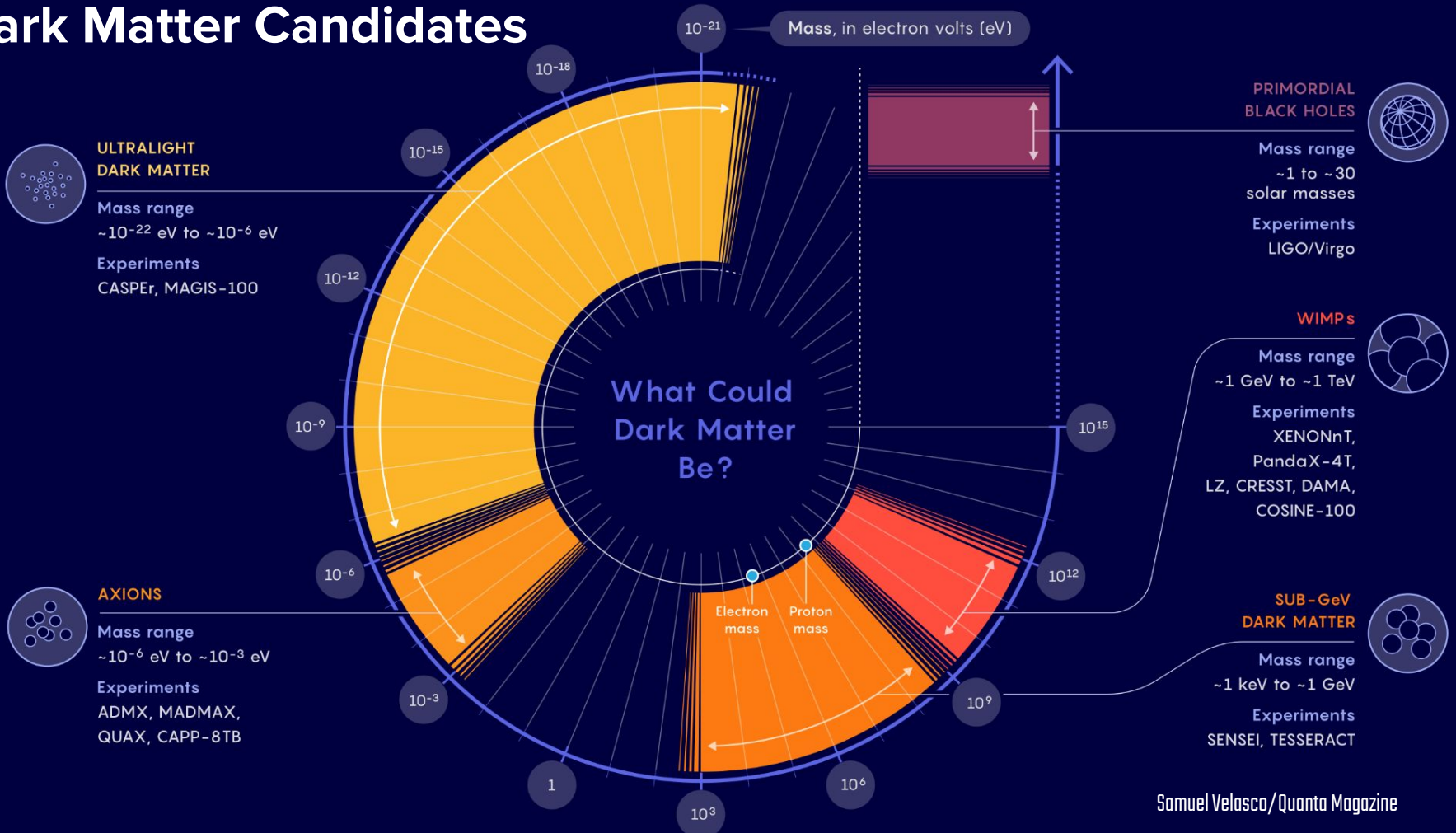

Dark Matter Candidates

DENNIS the MENACE

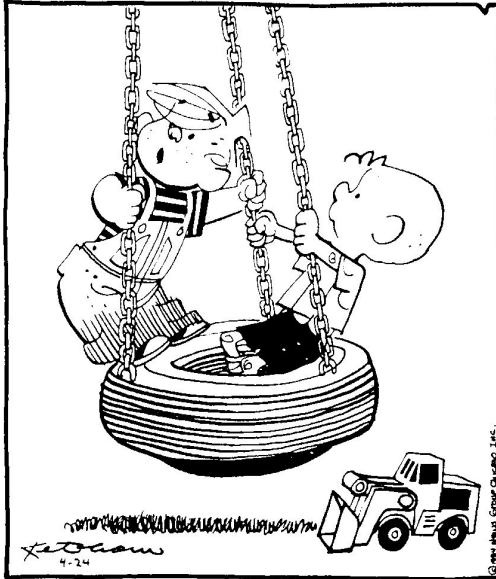

LOTS OF THINGS ARE INVISIBLE, BUT WE DON'T KNOW HOW MANY BECAUSE WE CAN'T SEE THEM.

Dark Matter might be more than just one thing, e.g:

- MACHOs are not fully excluded →
- Neutrinos DO contribute to HDM

Is there a complete **Dark Sector** with rich physics?

Is there more than one complete Dark Sector?

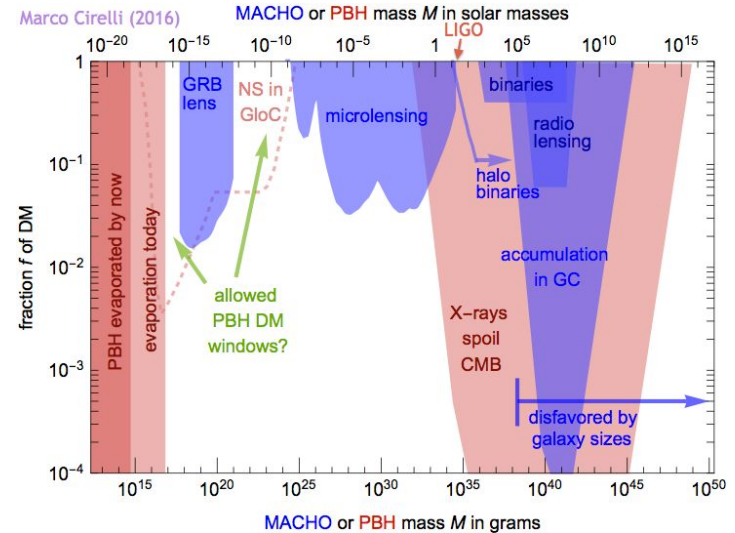

Dark Matter Candidates

DENNIS the MENACE



"LOTS OF THINGS ARE INVISIBLE, BUT WE DON'T KNOW HOW MANY BECAUSE WE CAN'T SEE THEM."

Dark Matter might be more than just one thing, e.g:

- MACHOs are not fully excluded
- Neutrinos DO contribute to HDM

Is there a complete **Dark Sector** with rich physics?

Is there more than one complete Dark Sector?

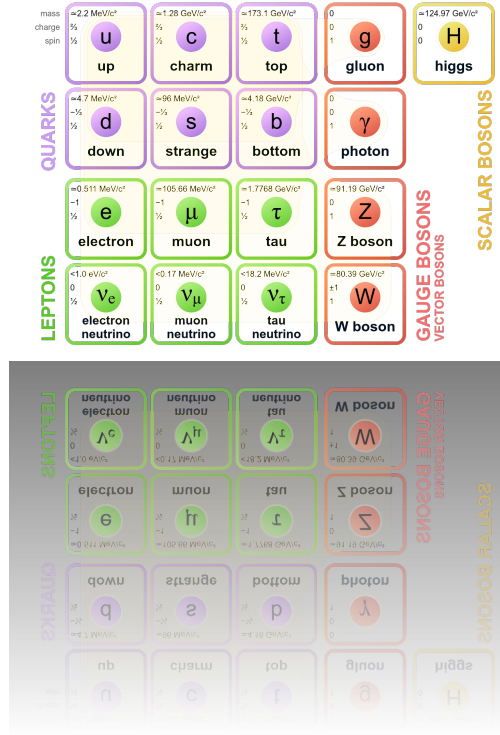

Dark Matter Detection

1. Production in Particle Colliders

- Looking for missing momentum in colliders
- LHC can already cover most of the mass ranges for main candidates (TeV scale)

2. Indirect Detection

- Detection of annihilation or decay products
- Surveys of dwarf spheroidal galaxies
- Axion conversion in strong magnetic fields

3. Direct Detection

- Searching for dark matter scattering with a target material
- Axion conversion in resonance cavities and ASTs

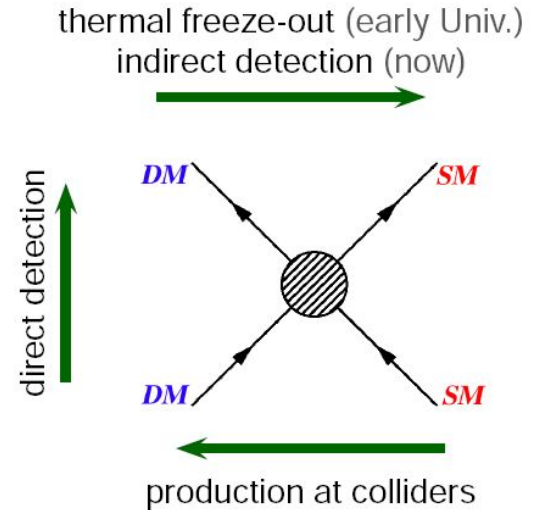

Detection of Dark Matter at Colliders

If DM particles are produced at high-E collisions, they escape detection - **missing energy and momentum**

- Collision events where high-E SM final state recoils against invisible DM particles
- Directly probing extensions to the SM, e.g., Supersymmetry (SUSY)
 - Lightest stable particle in some SUSY models are DM candidates (e.g. neutralino)
 - **No solid evidence for SUSY was found yet.**

LHC Run 3 started last week - **pp collisions at 13.6 TeV**

Fingers crossed...

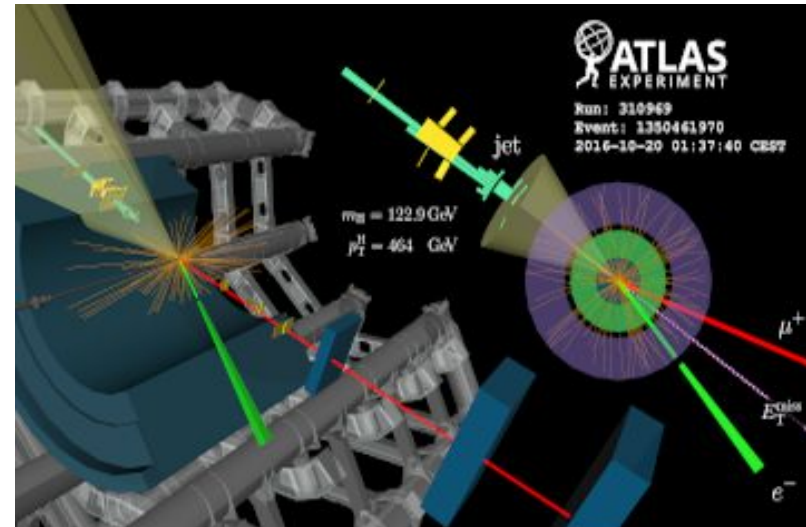
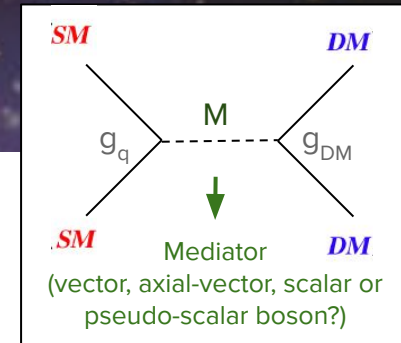

Indirect Detection of Dark Matter

Observation of products of DM annihilation or decay.

- Can provide a lot of information about DM - mass, annihilation cross section, half-life.
- Potential sources of high-E cosmic rays

Many different probes and sources:

- ★ Land and orbital cosmic ray observatories
- ★ Dwarf Spheroidal Galaxies - large DM density and fewer γ -ray sources
- ★ Solar axion decay signature in the magnetosphere of the Earth
- ★ Stellar or planetary symptoms

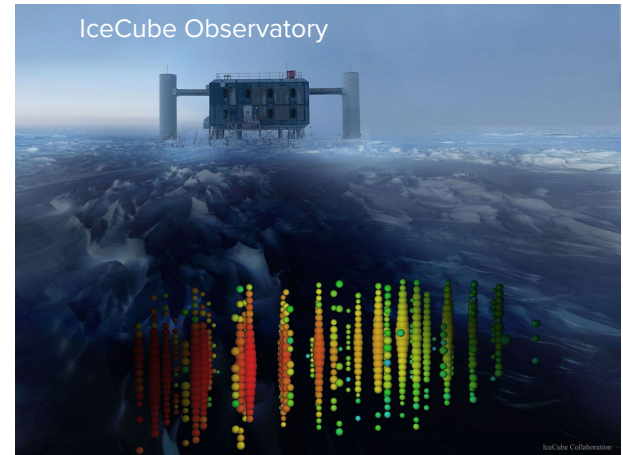
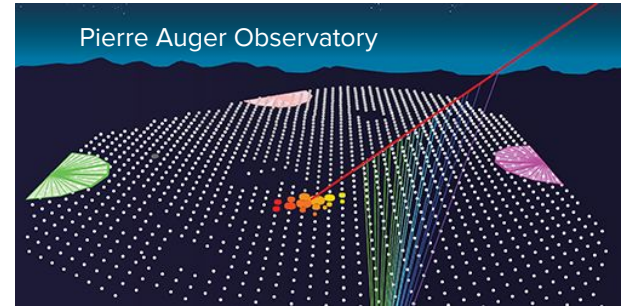

Indirect Detection of Dark Matter

Observation of products of DM annihilation or decay.

- Can provide a lot of information about DM - mass, annihilation cross section, half-life.
- Potential sources of high-E cosmic rays

Many different probes and sources:

- ★ Land and orbital cosmic ray observatories
- ★ Dwarf Spheroidal Galaxies - large DM density and fewer γ -ray sources
- ★ Solar axion decay signature in the magnetosphere of the Earth
- ★ Stellar or planetary symptoms



XMM-Newton X-ray space observatory

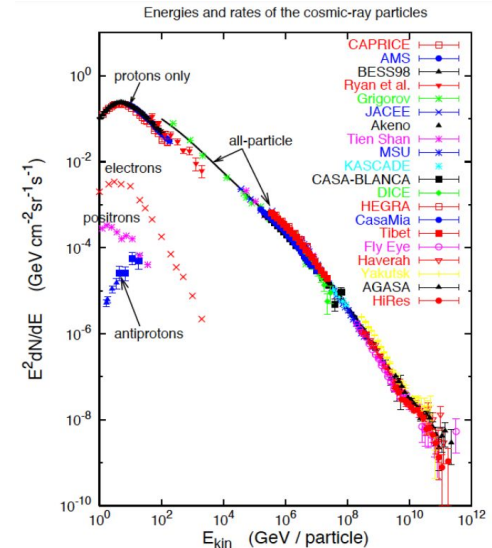

Direct Detection of (particle) Dark Matter

Particle DM direct detection experiments aim to measure the rate and energies of nuclear recoils caused by the scattering of dark matter particles with the nuclei in the target material.

Assuming our WIMP halo is composed of:

- WIMPs with mass, $M_\chi = 30 \text{ GeV}$
- WIMP density, $\rho_\chi = 0.4 \text{ GeV cm}^{-3}$
- Earth's velocity in the halo, $v_0 = 220 \text{ km s}^{-1}$

Using a Xe target (**A=131**) and considering the current best limit on the cross-section WIMP-nucleon,

$\sigma_{\text{own}} = 5.9 \times 10^{-48} \text{ cm}^2$ (Latest LZ result):

$$R_0 = \frac{2}{\sqrt{\pi}} \frac{N_A}{A} \frac{\rho_{\text{DM}}}{M_\chi} \sigma_0 v_0$$

~1 event
per tonne of Xe per month!

$E_R = 5 \text{ keV}$ avg. recoil energy

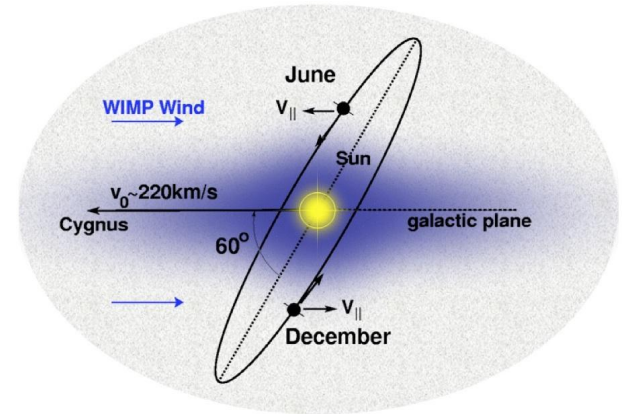

We're talking about VERY RARE events...

Direct Detection of (particle) Dark Matter

Particle DM direct detection experiments aim to measure the rate and energies of nuclear recoils caused by the scattering of dark matter particles with the nuclei in the target material.

Main detector types:

- Dual-phase noble element TPCs
 - LZ, XENONnT, DarkSide, DEAP
- Threshold detectors
 - PICO, PICASSO, COUPP
- Crystal scintillation
 - CRESST, COSINE
- Cryogenic Semiconductor detectors
 - CUORE, SuperCDMS

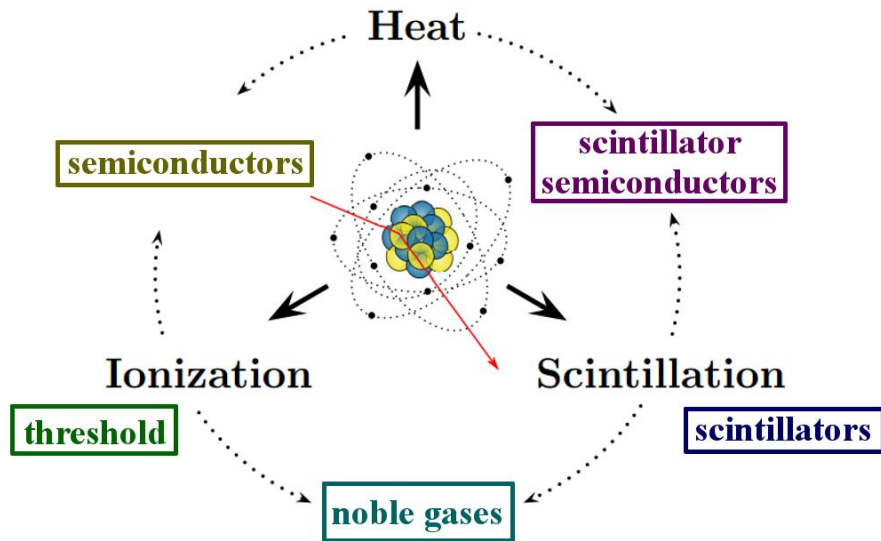

Direct Detection of (particle) Dark Matter

Particle DM direct detection experiments aim to measure the rate and energies of nuclear recoils caused by the scattering of dark matter particles with the nuclei in the target material.

Main detector types:

- Dual-phase noble element TPCs
 - LZ, XENONnT, DarkSide, DEAP
- Threshold detectors
 - PICO, PICASSO, COUPP
- Crystal scintillation
 - CRESST, COSINE
- Cryogenic Semiconductor detectors
 - CUORE, SuperCDMS

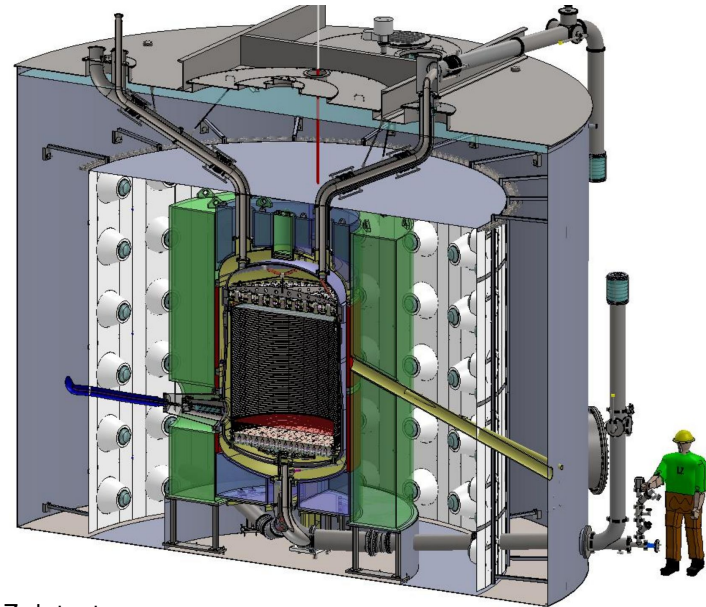

The LZ detector

Direct Detection of (particle) Dark Matter

Particle DM direct detection experiments aim to measure the rate and energies of nuclear recoils caused by the scattering of dark matter particles with the nuclei in the target material.

Main detector types:

- Dual-phase noble element TPCs
 - LZ, XENONnT, DarkSide, DEAP
- Threshold detectors
 - PICO, PICASSO, COUPP
- Crystal scintillation
 - CRESST, COSINE
- Cryogenic Semiconductor detectors
 - CUORE, SuperCDMS



CRESST detector

Direct Detection of (particle) Dark Matter

Particle DM direct detection experiments aim to measure the rate and energies of nuclear recoils caused by the scattering of dark matter particles with the nuclei in the target material.

Main detector types:

- Dual-phase noble element TPCs
 - LZ, XENONnT, DarkSide, DEAP
- Threshold detectors
 - PICO, PICASSO, COUPP
- Crystal scintillation
 - CRESST, COSINE
- Cryogenic Semiconductor detectors
 - CUORE, SuperCDMS

SuperCDMS detector

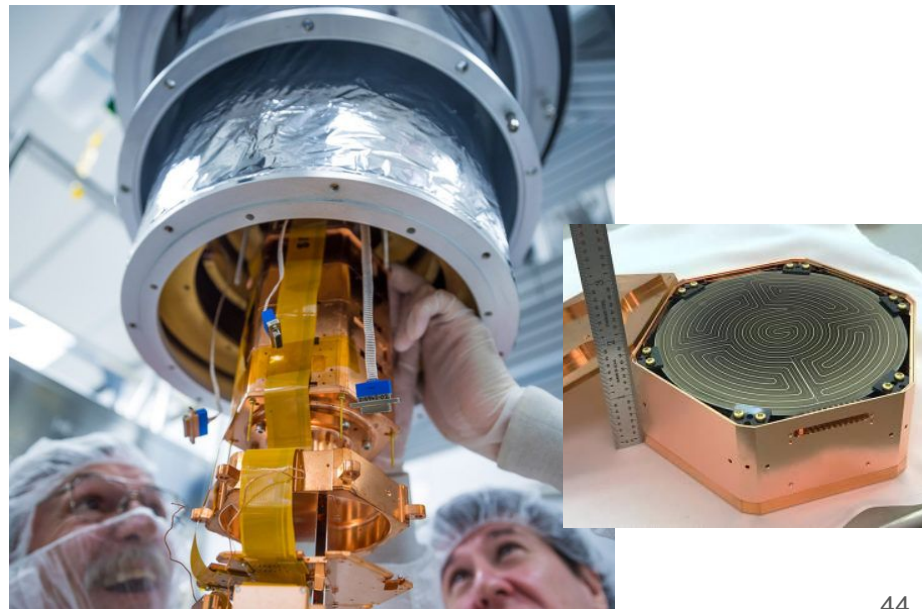

Direct Detection of (wave) Dark Matter

Axion DM direct detection experiments search for axion-photon conversion in strong magnetic fields - Primakoff effect - or via the axio-electric effect.

- ★ Resonance microwave cavity - enhanced axion conversion when cavity resonant frequency is tuned to axion mass
 - ADMX
- ★ Axion Helioscope - Optically obstructed X-ray sensor within a strong magnetic field
 - CAST, IAXO
- ★ Axio-electric effect - similar to photoelectric effect, an axion ionizes an atom in a target.

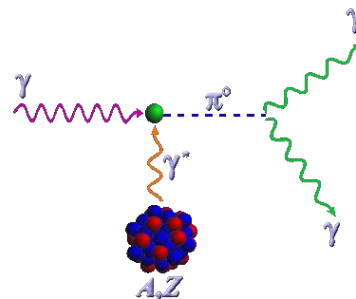

Pseudoscalar meson production via Primakoff effect

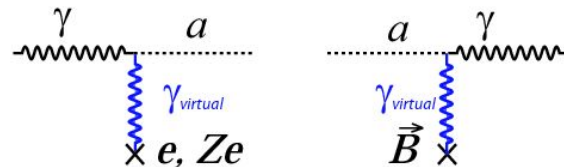

Direct Detection of (wave) Dark Matter

Axion DM direct detection experiments search for axion-photon conversion in strong magnetic fields - Primakoff effect - or via the axio-electric effect.

- ★ Resonance microwave cavity - enhanced axion conversion when cavity resonant frequency is tuned to axion mass
 - ADMX
- ★ Axion Helioscope - Optically obstructed X-ray sensor within a strong magnetic field
 - CAST, IAXO
- ★ Axio-electric effect - similar to photoelectric effect, an axion ionizes an atom in a target.

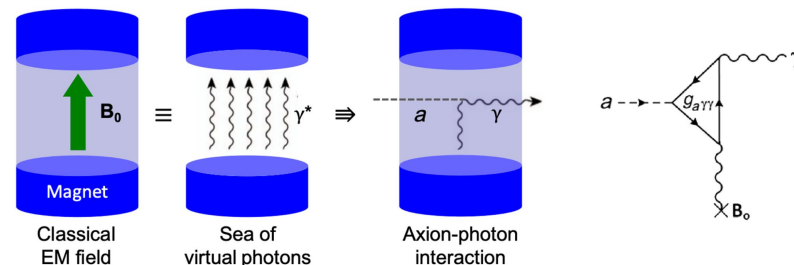

Direct Detection of (wave) Dark Matter

Axion DM direct detection experiments search for axion-photon conversion in strong magnetic fields - Primakoff effect - or via the axio-electric effect.

- ★ Resonance microwave cavity - enhanced axion conversion when cavity resonant frequency is tuned to axion mass
 - ADMX
- ★ Axion Helioscope - Optically obstructed X-ray sensor within a strong magnetic field
 - CAST, IAXO
- ★ Axio-electric effect - similar to photoelectric effect, an axion ionizes an atom in a target.



Thank you!





BACKUPS

Dark Matter Candidates

MACHOs

Massive Astrophysical Compact Halo Objects, such as neutron stars, white dwarfs, brown dwarfs, Jupiter-like planets, black holes. Mostly excluded by several evidences and observation.

Axions

Hypothetical pseudoscalar particle that could justify why CP-violating processes are not observed in strong interactions. Not produced thermally (cold). Also Axion-like Particles (ALPs).

Neutrinos

The most abundant particles in the universe aside from photons. Non-zero mass, weakly-interacting. Warm or Hot Dark Matter candidates - cannot form large scale structures like the ones observed.

WIMPs

Weakly Interacting Massive Particles, generic class of chargeless & heavy particles, produced thermally in the early Universe, that provide the inferred amount of non-baryonic dark matter.

Detector Requirements for a Rare Event Search

Large target mass or isotopic abundance:

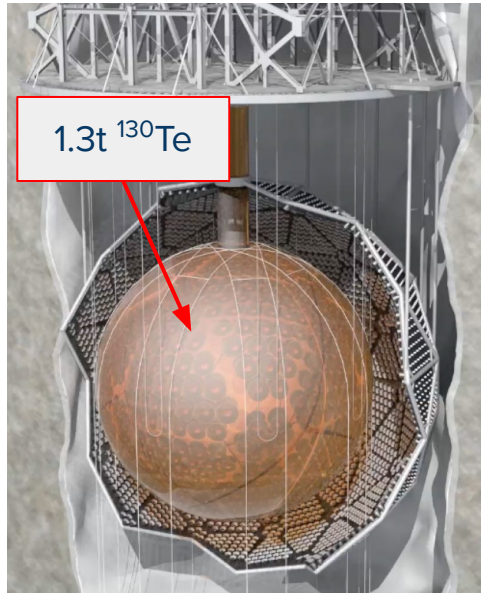

1.3t ^{130}Te

SNO+ ($\text{ov}\beta\beta$ ^{130}Te)

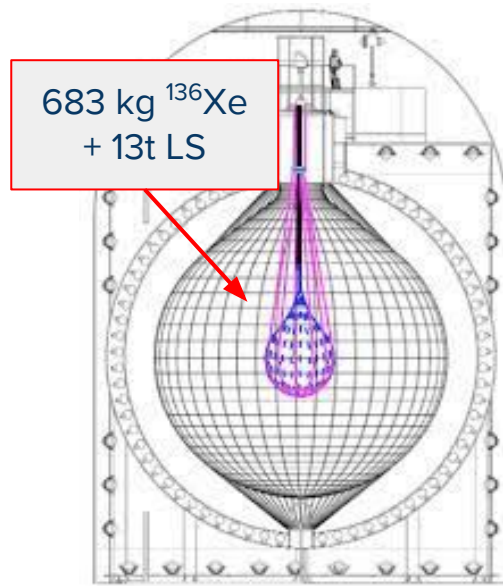

683 kg ^{136}Xe
+ 13t LS

KanLAND-Zen ($\text{ov}\beta\beta$ ^{136}Xe)

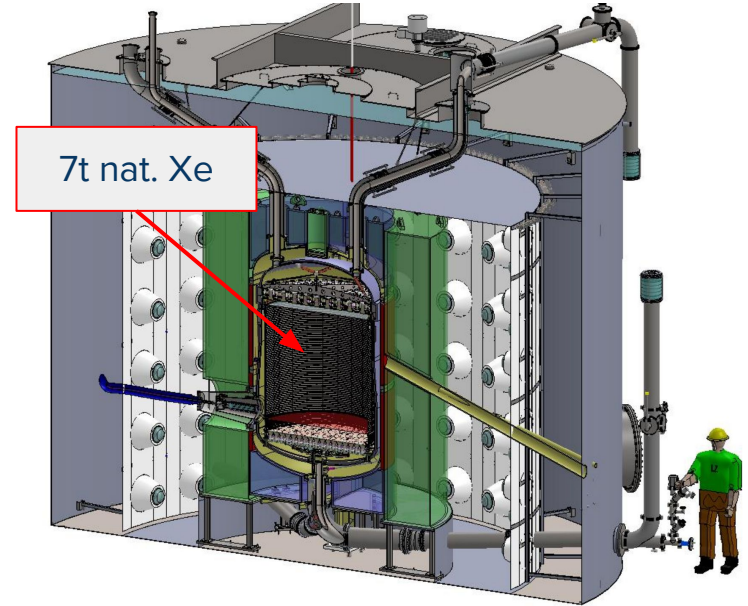

7t nat. Xe

LZ (dark matter)

Detector Requirements for a Rare Event Search

Ultra-low background (BG) environment

Reducing radioactive and cosmic radiation is critical in any rare event search!

1. Move underground!

- a. Usually over 1 km deep
- b. Using rock overburden to shield from penetrative cosmic ray muons

Decrease of muon and muon-induced BGs by several orders of magnitude!

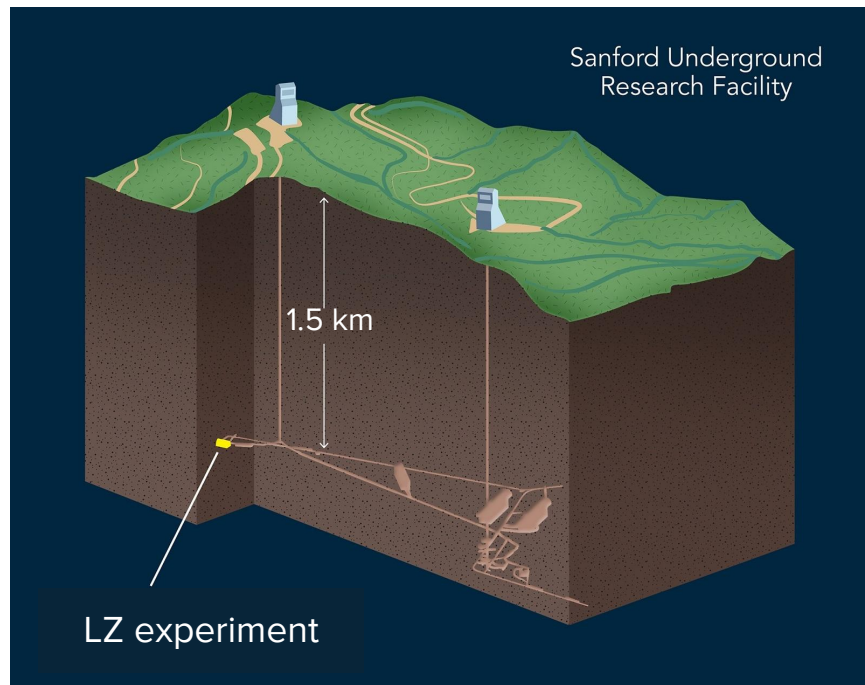

Detector Requirements for a Rare Event Search

Ultra-low background (BG) environment

Reducing radioactive and cosmic radiation is critical in any rare event search!

1. **Move underground!**
2. **High radiopurity detector materials**
 - a. All materials have some natural radioactivity
 - b. Prevent BG sources within detector structures
- closer to the target!
 - c. Also, build the detector in controlled environments to reduce contamination (dust, Radon, neutron activation, etc.)



Detector Requirements for a Rare Event Search

Ultra-low background (BG) environment

Reducing radioactive and cosmic radiation is critical in any rare event search!

1. **Move underground!**
2. **High radiopurity detector materials**
3. **Passive shielding**
 - a. Surround the detector with materials with high stopping power.
 - b. E.g., ancient lead or metals for γ -rays, HDPE or water for neutrons.
 - c. Use dense and massive target materials (fiducialization)

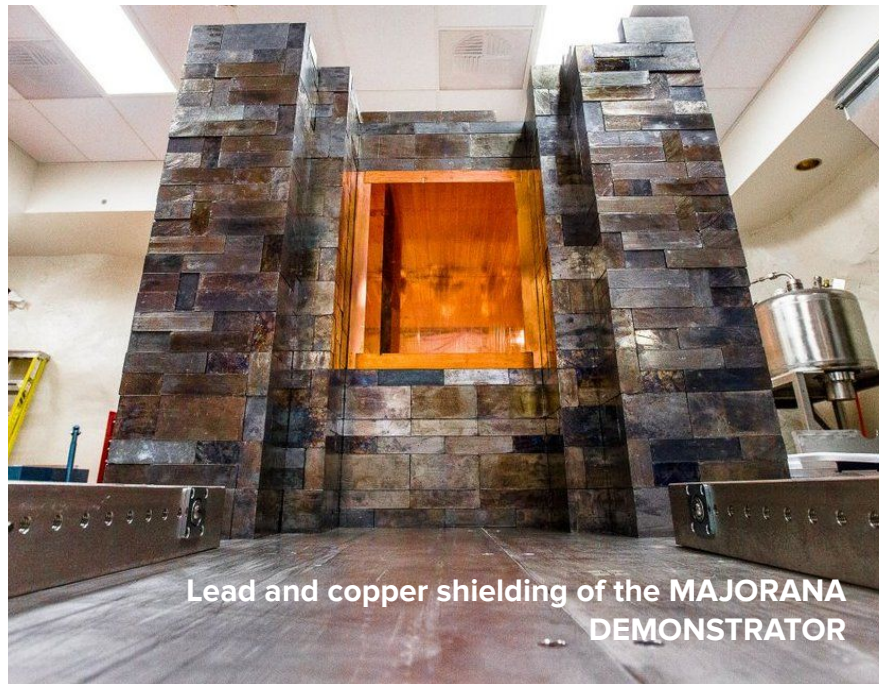

Lead and copper shielding of the MAJORANA DEMONSTRATOR

Detector Requirements for a Rare Event Search

Ultra-low background (BG) environment

Reducing radioactive and cosmic radiation is critical in any rare event search!

1. **Move underground!**
2. **High radiopurity detector materials**
3. **Passive shielding**
 - a. Surround the detector with materials with high stopping power.
 - b. E.g., ancient lead or metals for γ -rays, HDPE or water for neutrons.
 - c. Use dense and massive target materials (fiducialization)

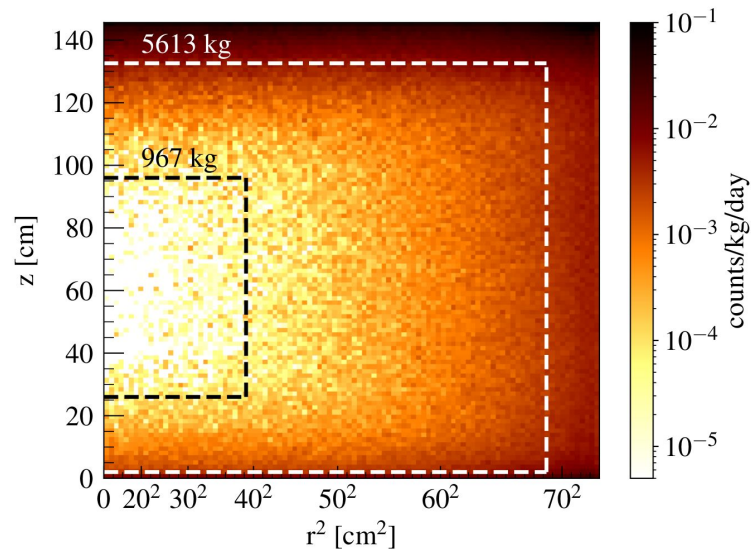

The strong attenuation of high-E γ -rays in liquid Xenon

Detector Requirements for a Rare Event Search

Ultra-low background (BG) environment

Reducing radioactive and cosmic radiation is critical in any rare event search!

1. **Move underground!**
2. **High radiopurity detector materials**
3. **Passive shielding**
4. **Active shielding**
 - a. Good position resolution allows single vs multiple scatter discrimination.
 - b. Deploy coincidence detectors (vetoes) that surround the main detector.

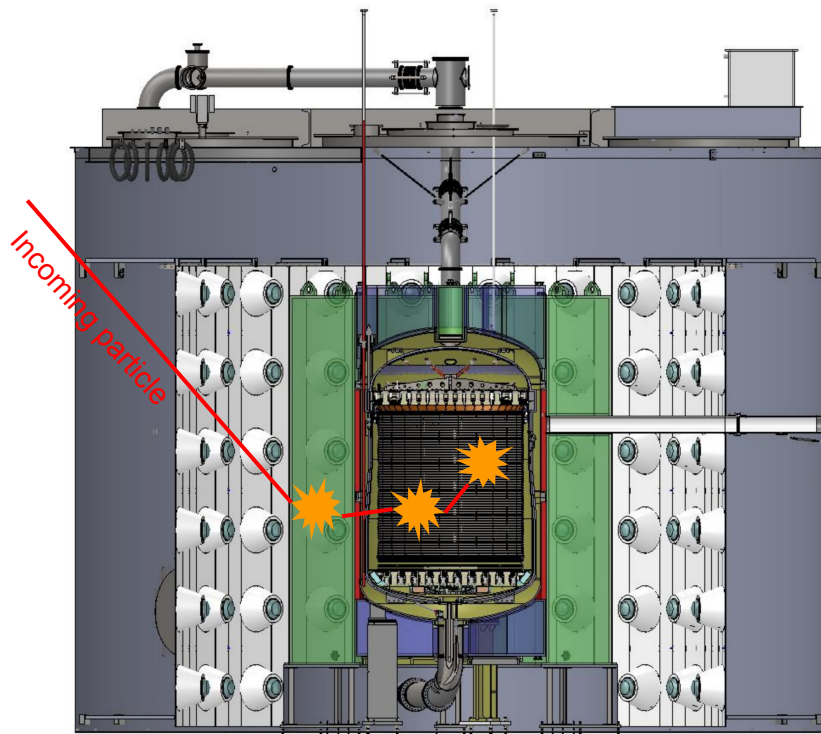

Detector Requirements for a Rare Event Search

Energy and position resolution

The $0\nu\beta\beta$ decay signal is only distinguishable from the $2\nu\beta\beta$ decay BG by energy resolution.

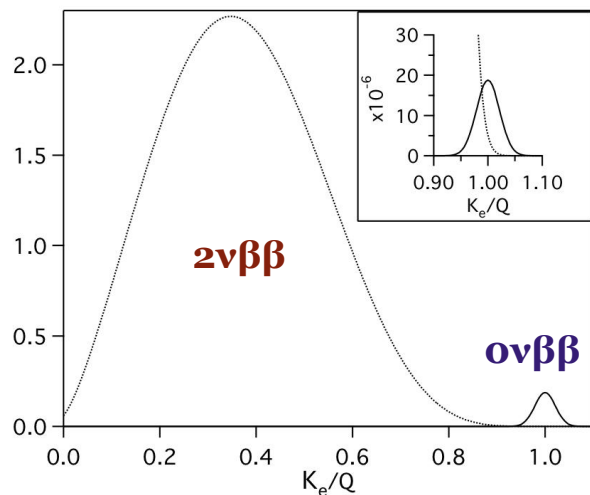

A good position resolution might help to identify the type of interaction, e.g., distinguish the individual tracks from both β in the decay.

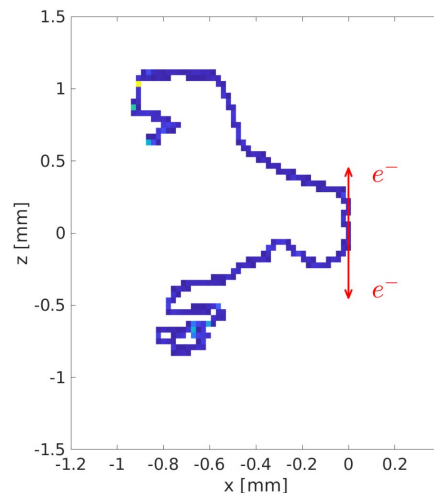

Background Discrimination

Some detectors allow clever background discrimination techniques during data analysis, e.g. electron vs nuclear recoil in WIMP dark matter detectors:

- Dark matter is more likely to interact with the nucleus of an atom of the target.
- Backgrounds from γ -rays and β particles are more likely to interact with atomic electrons.
- **However, neutrons will mimic WIMP signals by scattering off nuclei.**

Some other detectors can use pulse-shape discrimination for the same effect.

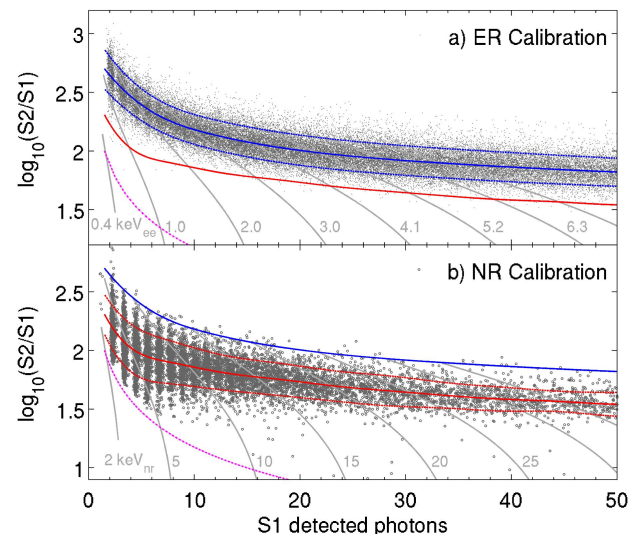

Simulation and Background Modelling

Fundamental in experimental physics!

Predict and model the BGs in the detector with detailed Monte Carlo simulations aided by:

- Detailed models of physics processes.
- Radioactive assays of detector materials.
- Measurements of environmental BGs in the lab.
- **Detector calibrations.**
- Detailed detector geometry models, material properties and **detector response**

These detailed models will then be used to constrain the observed BGs and place limits on the signal.

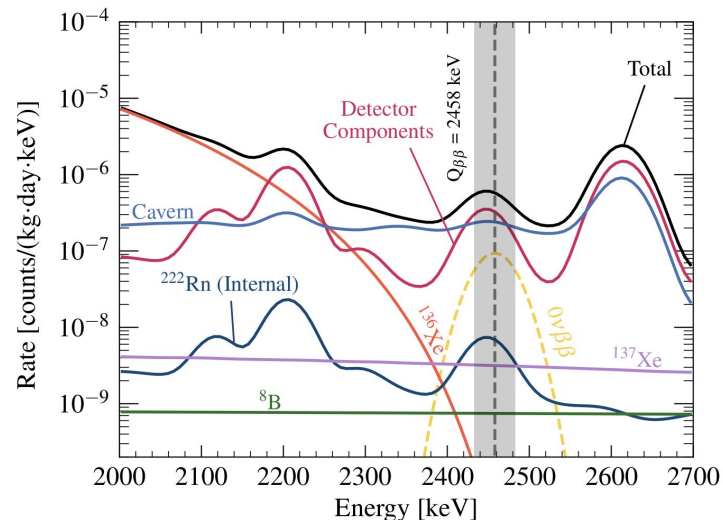

Expected background rates for LZ around the ^{136}Xe $0\nu\beta\beta$ decay energy region

Dual Phase Noble Element TPCs

Ultra-low background rare event observatories using **Xenon** or **Argon** as targets.

- ❖ Xenon is very dense (2.9 g/cm^3)
 - Self-shielding and active vetoing
- ❖ High Atomic mass enhances WIMP cross-section

Record **scintillation** and **ionization** from interactions with the target.

- ❖ Discrimination of particle recoiling with the electrons (ER) or **nuclei (NR)** of the target.

Low energy threshold ($\sim \text{keV}$) and excellent energy and position resolution.

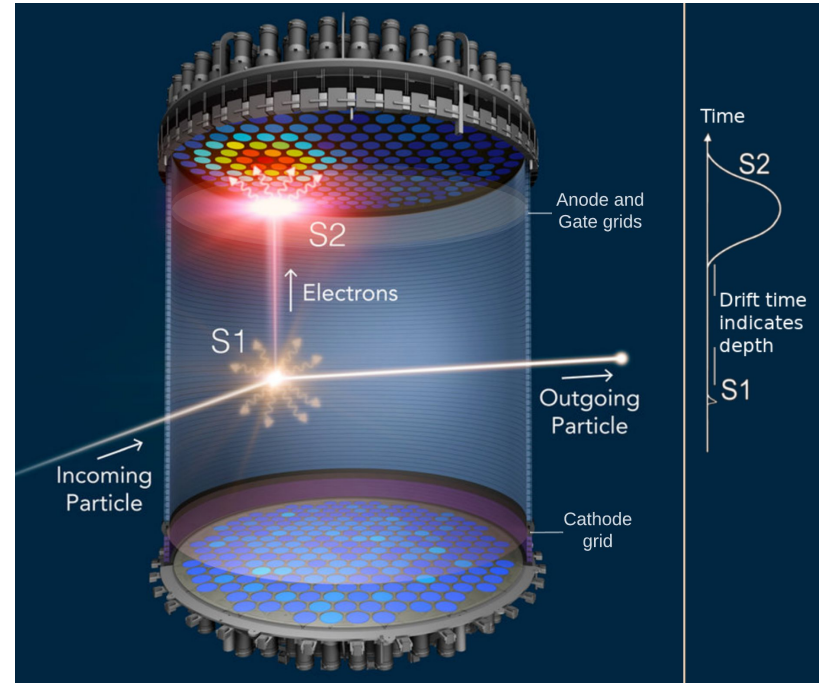

Dual Phase Noble Element TPCs

Working principle:

1. Particle interaction excites and ionizes target material.
 2. Scintillation is promptly detected (S1).
 3. Ionization drift towards the gas by electric field.
 4. Stronger field extracts electrons to produce electroluminescence (S2).
- ❖ Time between S1 and S2 indicates **depth**
 - ❖ Light map of S2 indicates **XY position**
 - ❖ S1 and S2 size used to reconstruct **Energy**

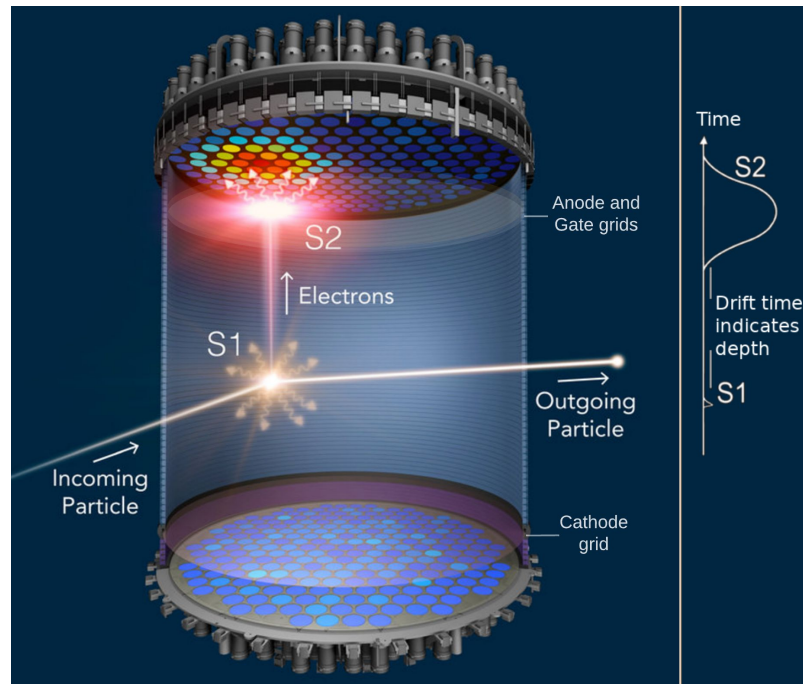

The LUX-ZEPLIN Detector

A 10 tonne liquid Xe ultra-low background dark matter detector. Rare event observatory: dark matter, $0\nu\beta\beta$ decay, neutrinos, axions, etc.

Composed of 3 distinct detectors:

1. 7 tonne liquid Xe TPC with 494 PMTs **(1)**
2. ~3 tonne Xe “skin” detector around TPC
3. 17.3 tonne Gd-loaded liquid scintillator Outer Detector with 120 PMTs **(2)**

228 tonne water shield and muon veto **(4)**

1478 m underground in a gold mine in the USA.

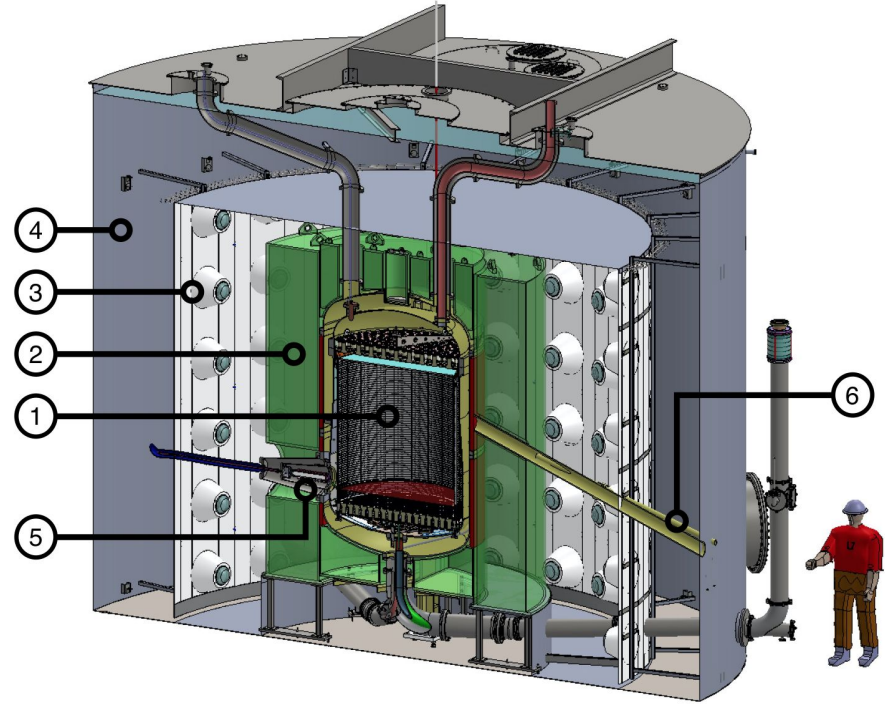

The LUX-ZEPLIN Detector

A 10 tonne liquid Xe ultra-low background dark matter detector.

Rare event observatory: dark matter, $0\nu\beta\beta$ decay, neutrinos, axions, etc.

1. TPC with 1.5×1.5 m and **7 tonnes** of liquid Xe, observed by **494** 3-inch PMTs
2. Outer detector (Gd-loaded liquid scintillator)
3. Array of **120** 8-inch PMTs
4. Water tank (228 tonnes)
5. High-voltage umbilical
6. Neutron source tube
7. Xe conduit

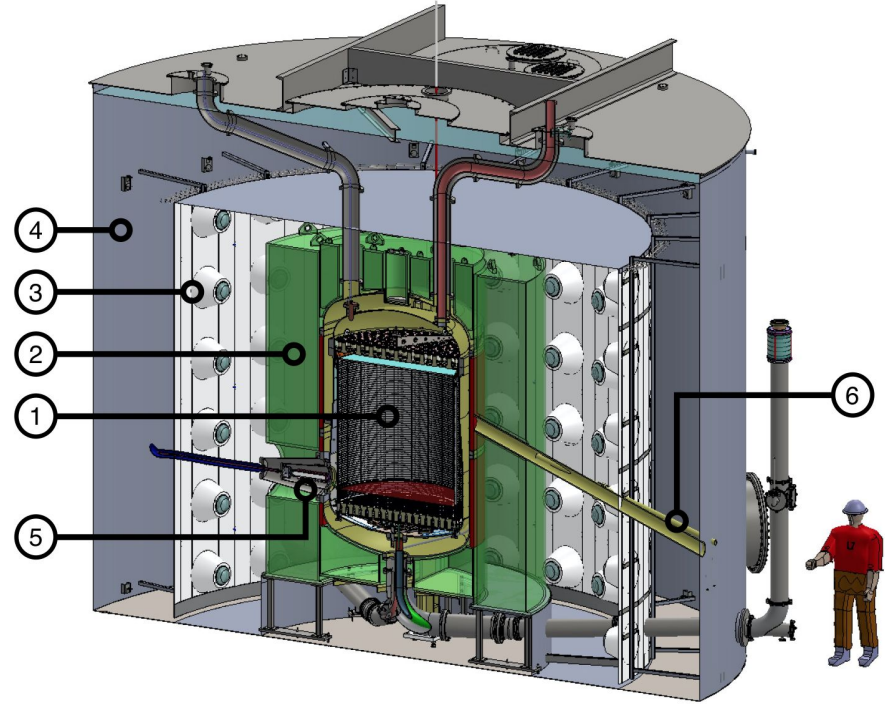

The LUX-ZEPLIN Detector

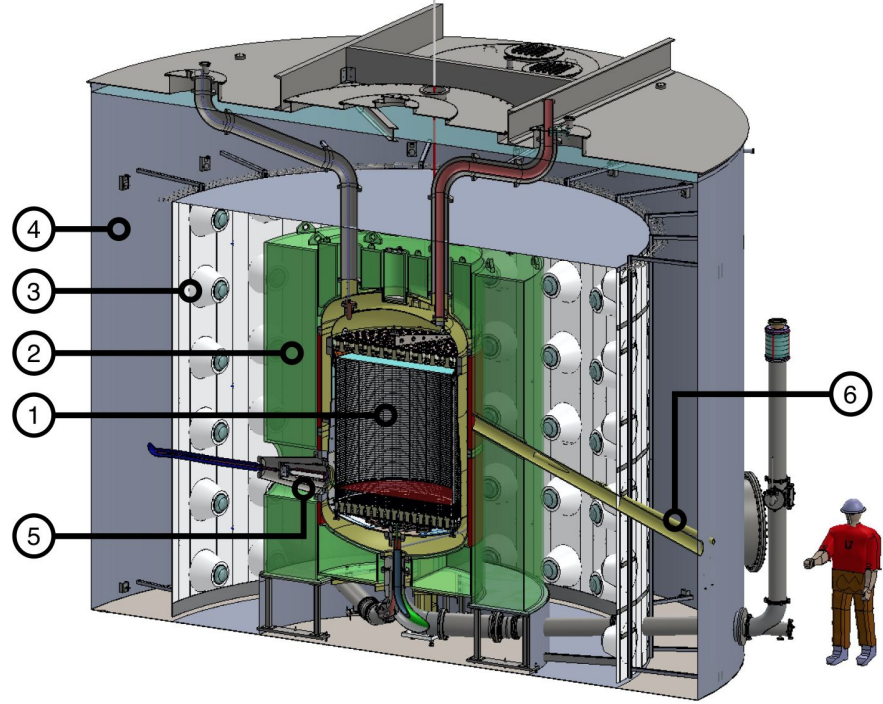

The LUX-ZEPLIN Detector

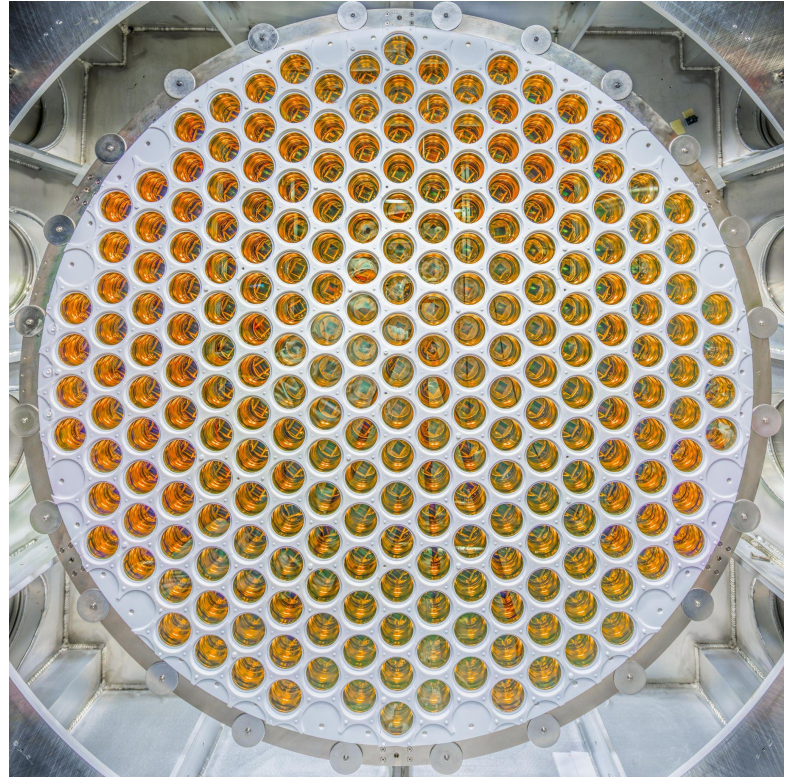

The LUX-ZEPLIN Detector



The LUX-ZEPLIN Detector



The LUX-ZEPLIN Detector

